

User Manual

SpeedFace-V5L Series

Date: June 2022

Doc Version: 1.0

English

Thank you for choosing our product. Please read the instructions carefully before operation. Follow these instructions to ensure that the product is functioning properly. The images shown in this manual are for illustrative purposes only.



For further details, please visit our Company's website
www.zkteco.com.

Copyright © 2022 ZKTECO CO., LTD. All rights reserved.

Without the prior written consent of ZKTeco, no portion of this manual can be copied or forwarded in any way or form. All parts of this manual belong to ZKTeco and its subsidiaries (hereinafter the "Company" or "ZKTeco").

Trademark

ZKTeco is a registered trademark of ZKTeco. Other trademarks involved in this manual are owned by their respective owners.

Disclaimer

This manual contains information on the operation and maintenance of the ZKTeco equipment. The copyright in all the documents, drawings, etc. in relation to the ZKTeco supplied equipment vests in and is the property of ZKTeco. The contents hereof should not be used or shared by the receiver with any third party without express written permission of ZKTeco.

The contents of this manual must be read as a whole before starting the operation and maintenance of the supplied equipment. If any of the content(s) of the manual seems unclear or incomplete, please contact ZKTeco before starting the operation and maintenance of the said equipment.

It is an essential pre-requisite for the satisfactory operation and maintenance that the operating and maintenance personnel are fully familiar with the design and that the said personnel have received thorough training in operating and maintaining the machine/unit/equipment. It is further essential for the safe operation of the machine/unit/equipment that personnel has read, understood and followed the safety instructions contained in the manual.

In case of any conflict between terms and conditions of this manual and the contract specifications, drawings, instruction sheets or any other contract-related documents, the contract conditions/documents shall prevail. The contract specific conditions/documents shall apply in priority.

ZKTeco offers no warranty, guarantee or representation regarding the completeness of any information contained in this manual or any of the amendments made thereto. ZKTeco does not extend the warranty of any kind, including, without limitation, any warranty of design, merchantability or fitness for a particular purpose.

ZKTeco does not assume responsibility for any errors or omissions in the information or documents which are referenced by or linked to this manual. The entire risk as to the results and performance obtained from using the information is assumed by the user.

ZKTeco in no event shall be liable to the user or any third party for any incidental, consequential, indirect, special, or exemplary damages, including, without limitation, loss of business, loss of profits, business interruption, loss of business information or any pecuniary loss, arising out of, in connection with, or relating to the use of the information contained in or referenced by this manual, even if ZKTeco has been advised of the possibility of such damages.

This manual and the information contained therein may include technical, other inaccuracies or typographical errors. ZKTeco periodically changes the information herein which will be incorporated into new additions/amendments to the manual. ZKTeco reserves the right to add, delete, amend or modify the information contained in the manual from time to time in the form of circulars, letters, notes, etc. for better operation and safety of the machine/unit/equipment. The said additions or amendments are meant for improvement /better operations of the machine/unit/equipment and such amendments shall not give any right to claim any compensation or damages under any circumstances.

ZKTeco shall in no way be responsible (i) in case the machine/unit/equipment malfunctions due to any non-compliance of the instructions contained in this manual (ii) in case of operation of the machine/unit/equipment beyond the rate limits (iii) in case of operation of the machine and equipment in conditions different from the prescribed conditions of the manual.

The product will be updated from time to time without prior notice. The latest operation procedures and relevant documents are available on <http://www.zkteco.com>.

If there is any issue related to the product, please contact us.

ZKTeco Headquarters

Address ZKTeco Industrial Park, No. 32, Industrial Road,
Tangxia Town, Dongguan, China.

Phone +86 769 - 82109991

Fax +86 755 - 89602394

For business related queries, please write to us at: sales@zkteco.com.

To know more about our global branches, visit www.zkteco.com.

About the Company

ZKTeco is one of the world's largest manufacturer of RFID and Biometric (Fingerprint, Facial, Finger-vein) readers. Product offerings include Access Control readers and panels, Near & Far-range Facial Recognition Cameras, Elevator/floor access controllers, Turnstiles, License Plate Recognition (LPR) gate controllers and Consumer products including battery-operated fingerprint and face-reader Door Locks. Our security solutions are multi-lingual and localized in over 18 different languages. At the ZKTeco state-of-the-art 700,000 square foot ISO9001-certified manufacturing facility, we control manufacturing, product design, component assembly, and logistics/shipping, all under one roof.

The founders of ZKTeco have been determined for independent research and development of biometric verification procedures and the productization of biometric verification SDK, which was initially widely applied in PC security and identity authentication fields. With the continuous enhancement of the development and plenty of market applications, the team has gradually constructed an identity authentication ecosystem and smart security ecosystem, which are based on biometric verification techniques. With years of experience in the industrialization of biometric verifications, ZKTeco was officially established in 2007 and now has been one of the globally leading enterprises in the biometric verification industry owning various patents and being selected as the National High-tech Enterprise for 6 consecutive years. Its products are protected by intellectual property rights.

About the Manual

This manual introduces the operations of **SpeedFace-V5L/ SpeedFace-V5L[TD]/ SpeedFace-V5L[TI]**.

All figures displayed are for illustration purposes only. Figures in this manual may not be exactly consistent with the actual products.

Features and parameters with ★ are not available in all devices.

Document Conventions

Conventions used in this manual are listed below:

GUI Conventions

For Software	
Convention	Description
Bold font	Used to identify software interface names e.g., OK , Confirm , Cancel .
>	Multi-level menus are separated by these brackets. For example, File > Create > Folder.
For Device	
Convention	Description
< >	Button or key names for devices. For example, press <OK>.
[]	Window names, menu items, data table, and field names are inside square brackets. For example, pop up the [New User] window.
/	Multi-level menus are separated by forwarding slashes. For example, [File/Create/Folder].

Symbols





Convention	Description
	This represents a note that needs to pay more attention to.
	The general information which helps in performing the operations faster.
	The information which is significant.
	Care taken to avoid danger or mistakes.
	The statement or event that warns of something or that serves as a cautionary example.

Table of Contents

DATA SECURITY STATEMENT	8
SAFETY MEASURES	8
1 OVERVIEW	11
2 INSTRUCTION FOR USE	11
2.1 FINGER POSITIONING	11
2.2 STANDING POSITION, FACIAL EXPRESSION AND STANDING POSTURE	12
2.3 FACE REGISTRATION	13
2.4 STANDBY INTERFACE.....	14
2.5 VIRTUAL KEYBOARD.....	16
2.6 VERIFICATION MODE	17
2.6.1 FINGERPRINT VERIFICATION.....	17
2.6.2 CARD VERIFICATION	20
2.6.3 FACIAL VERIFICATION	23
2.6.4 PASSWORD VERIFICATION.....	27
2.6.5 COMBINED VERIFICATION.....	29
3 MAIN MENU	31
4 USER MANAGEMENT.....	33
4.1 USER REGISTRATION	33
4.1.1 REGISTER A USER ID AND NAME	33
4.1.2 SETTING THE USER ROLE	34
4.1.3 REGISTER FINGERPRINT.....	35
4.1.4 REGISTER FACE	36
4.1.5 REGISTER CARD NUMBER.....	37
4.1.6 REGISTER PASSWORD.....	38
4.1.7 REGISTER USER PHOTO	39
4.1.8 ACCESS CONTROL ROLE	39
4.2 SEARCH USER.....	40
4.3 EDIT USER.....	41
4.4 DELETING USER.....	41
4.5 DISPLAY STYLE.....	42
5 USER ROLE	43
6 COMMUNICATION SETTINGS.....	45
6.1 NETWORK SETTINGS	45
6.2 SERIAL COMM★.....	46
6.3 PC CONNECTION	47
6.4 WIRELESS NETWORK.....	48
6.5 CLOUD SERVER SETTING	50
6.6 WIEGAND SETUP	51
6.6.1 WIEGAND INPUT	51
6.6.2 WIEGAND OUTPUT	53

6.7	NETWORK DIAGNOSIS.....	54
7	SYSTEM SETTINGS.....	55
7.1	DATE AND TIME.....	55
7.2	ACCESS LOGS SETTING.....	57
7.3	FACE PARAMETERS.....	58
7.4	FINGERPRINT PARAMETERS.....	60
7.5	VIDEO INTERCOM PARAMETERS.....	61
7.6	SECURITY SETTINGS.....	62
7.7	FACTORY RESET.....	63
7.8	DETECTION MANAGEMENT★.....	64
8	PERSONALIZE SETTINGS.....	67
8.1	INTERFACE SETTINGS.....	67
8.2	VOICE SETTINGS.....	68
8.3	BELL SCHEDULES.....	69
8.4	PUNCH STATES OPTIONS.....	70
8.5	SHORTCUT KEYS MAPPINGS.....	71
9	DATA MANAGEMENT.....	72
9.1	DELETE DATA.....	72
10	ACCESS CONTROL.....	74
10.1	ACCESS CONTROL OPTIONS.....	75
10.2	TIME SCHEDULE.....	76
10.3	HOLIDAYS.....	78
10.4	COMBINED VERIFICATION.....	79
10.5	ANTI-PASSBACK SETUP.....	80
10.6	DURESS OPTIONS SETTINGS.....	81
11	ATTENDANCE SEARCH.....	82
12	AUTOTEST.....	84
13	SYSTEM INFORMATION.....	85
14	LAN VIDEO INTERCOM FUNCTION SETTINGS★.....	86
14.1	INSTALLING ZKBIO VMS PLUGIN IN THE ZKBIOSECURITY SOFTWARE.....	86
14.2	CONFIGURATION PARAMETERS.....	87
14.3	VIDEO PREVIEW ON THE ZKBIOSECURITY SOFTWARE.....	90
14.4	MAKE A CALL ON THE DEVICE.....	91
15	CONNECT TO ZKBIOACCESS MTD SOFTWARE★.....	93
15.1	SET THE COMMUNICATION ADDRESS.....	93
15.2	ADD DEVICE ON THE SOFTWARE.....	94
15.3	ADD PERSONNEL ON THE SOFTWARE.....	95
15.4	REAL-TIME MONITORING ON THE ZKBIOACCESS MTD SOFTWARE.....	95
16	CONNECTING TO ZKBIO TALK SOFTWARE★.....	97
17	CONNECTING TO ZSMART APP★.....	100

17.1	ADDING DEVICE ON THE ZSMART APP.....	100
17.2	VIDEO PHONE CONNECTION.....	102
18	CONNECTING TO SIP★.....	103
18.1	LOCAL AREA NETWORK USE.....	104
18.2	SIP SERVER.....	110
19	CONNECTING TO BLUETOOTH LOCK★.....	112
19.1	BIND DEVICE.....	112
19.2	CHANGE PASSWORD.....	114
19.3	DELETE PASSWORD.....	116
19.4	UNBIND DEVICE.....	116
19.5	UNLOCK.....	118
APPENDIX 1	119
	REQUIREMENTS OF LIVE COLLECTION AND REGISTRATION OF VISIBLE LIGHT FACE IMAGES.....	119
	REQUIREMENTS FOR VISIBLE LIGHT DIGITAL FACE IMAGE DATA.....	120
APPENDIX 2	121
	PRIVACY POLICY.....	121
	ECO-FRIENDLY OPERATION.....	124

Data Security Statement

ZKTeco, as a smart product supplier, may also need to know and collect some of your personal information in order to better assist you in using ZKTeco's goods and services, and will treat your privacy carefully by developing a Privacy Policy.

Please read and understand completely all the privacy protection policy regulations and key points that appear on the device before using ZKTeco products.

As a product user, you must comply with applicable laws and regulations related to personal data protection when collecting, storing, and using personal data, including but not limited to taking protective measures for personal data, such as performing reasonable rights management for devices, strengthening the physical security of device application scenarios, and so on.

Safety Measures

The below instructions intend to ensure that the user can use the product correctly to avoid danger or property loss. The following precautions are to keep users safe and prevent any damage. Please read carefully before installation.

 Noncompliance with instructions could lead to product damage or physical injury (may even cause death).

1. **Read, follow, and retain instructions** - All safety and operational instructions must be properly read and followed before bringing the device into service.
2. **Do not ignore warnings** - Adhere to all warnings on the unit and in the operating instructions.
3. **Accessories** - Use only manufacturer-recommended or product-sold accessories. Please do not use any other components other than manufacturer suggested materials.
4. **Precautions for the installation** – Do not place this device on an unstable stand or frame. It may fall and cause serious injury to persons and damage to the device.
5. **Service** - Do not try to service this unit yourself. Opening or removing covers may expose you to hazardous voltages or other hazards.
6. **Damage requiring service** - Disconnect the system from the Mains AC or DC power source and refer service personnel under the following conditions:
 - When cord or connection control is affected.
 - When the liquid spilled, or an item dropped into the system.
 - If exposed to water or due to inclement weather (rain, snow, and more).
 - If the system is not operating normally, under operating instructions.

Just change controls defined in operating instructions. Improper adjustment of the controls may result in damage and involve a qualified technician to return the device to normal operation.

And do not connect multiple devices to one power adapter as adapter overload can cause over-

heat or fire hazard.

7. **Replacement parts** - When replacement parts are needed, service technicians must only use replacement parts provided by the supplier. Unauthorized substitutes can result in a burn, shock, or other hazards.
8. **Safety check** - On completion of service or repair work on the unit, ask the service technician to perform safety checks to ensure proper operation of the device.
9. **Power sources** - Operate the system only from the label's power source form. If the sort of power supply to use is unclear, call your dealer.
10. **Lightning** - Can install external lightning conductors to protect against electrical storms. It stops power-ups from destroying the system.

Recommended installing the devices in areas with limited access.

Electrical Safety

- Before connecting an external cable to the device, complete grounding properly, and set up surge protection; otherwise, static electricity will damage the mainboard.
- Make sure that the power has been disconnected before you wire, install, or dismantle the device.
- Ensure that the signal connected to the device is a weak-current (switch) signal; otherwise, components of the device will get damaged.
- Ensure that the standard voltage applicable in your country or region is applied. If you are not sure about the endorsed standard voltage, please consult your local electric power company. Power mismatch may cause a short circuit or device damage.
- In the case of power supply damage, return the device to the professional technical personnel or your dealer for handling.
- To avoid interference, keep the device far from high electromagnetic radiation devices, such as generators (including electric generators), radios, televisions, (especially CRT) monitors, or speakers.

Operation Safety

- If smoke, odour, or noise rise from the device, turn off the power at once and unplug the power cable, and then please contact the service centre.
- Transportation and other unpredictable causes may damage the device hardware. Check whether the device has any intense damage before installation.
- If the device has major defects that you cannot solve, contact your dealer as soon as possible.
- Dust, moisture, and abrupt temperature changes can affect the device's service life. You are advised not to keep the device under such conditions.
- Do not keep the device in a place that vibrates. Handle the device with care. Do not place heavy objects on top of the device.

- Do not apply rosin, alcohol, benzene, pesticides, and other volatile substances that may damage the device enclosure. Clean the device accessories with a piece of soft cloth or a small amount of cleaning agent.
- If you have any technical questions regarding usage, contact certified or experienced technical personnel.

 **Note:**

- Make sure whether the positive polarity and negative polarity of the DC 12V power supply is connected correctly. A reverse connection may damage the device. It is not advisable to connect the AC 24V power supply to the DC 12V input port.
- Make sure to connect the wires following the positive polarity and negative polarity shown on the device's nameplate.
- The warranty service does not cover accidental damage, damage caused by mis-operation, and damage due to independent installation or repair of the product by the user.

1 Overview

SpeedFace-V5L Series using intelligent engineering facial recognition algorithms and the latest computer vision technology. It supports Fingerprint, facial verification with large capacity and speedy recognition, also the facial camera support QR code with Mobile APP, as well as improves security performance in all aspects.

SpeedFace-V5L Series adopts touchless recognition technology and masked individual identification which eliminates hygiene concerns effectively. It is also equipped with ultimate antispoofing algorithm for facial recognition against almost all types of fake photos and videos attack. Besides, its facial camera supports QR code, PDF417, Data Matrix, MicroPDF417, Aztec, and so on, with ZKBioAccess IVS Mobile APP support Dynamic QR code for T&A/A&C.

The TD/TI Version with mask detection help reduce the spread of germs and help prevent infections straightly at each access point of any premises and public areas such as hospitals, factories, schools, commercial buildings, stations during the recent global public health issue with its masked individual identification function during facial verification.

SpeedFace-V5L Series support video intercom Both via mobile app ZSmart and via PC software ZKBioTalk, also they are integrated ONVIF Video protocol, so that they can connect to Onvif NVR to Video surveillance and recording.

2 Instruction for Use

Before getting into the device features and functions, it is recommended to be familiar with the below fundamentals.

2.1 Finger Positioning

Recommended fingers: Index, middle, or ring fingers; avoid using the thumb or pinky, as they are difficult to accurately press onto the fingerprint reader.

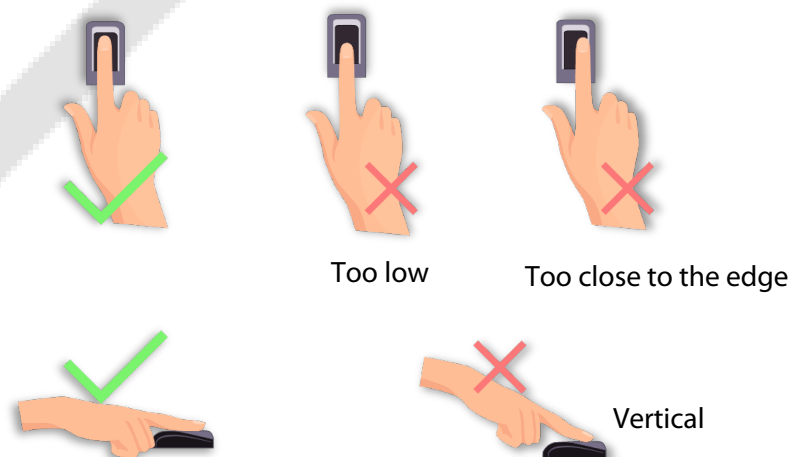

Note: Please use the correct method when pressing your fingers onto the fingerprint reader for registration and identification. Our company will assume no liability for recognition issues that may result from incorrect usage of the product. We reserve the right of final interpretation and modification concerning this point.

2.2 Standing Position, Facial Expression and Standing Posture

● The Recommended Distance

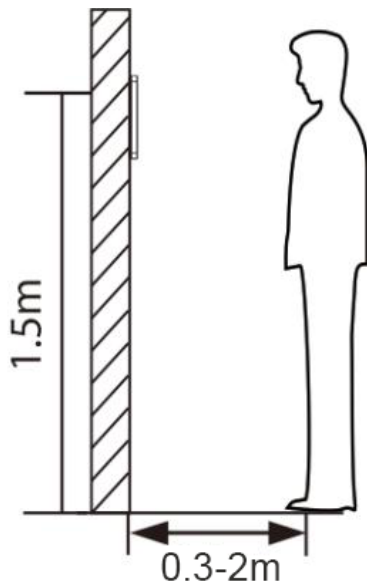

The distance between the device and a user whose height is in a range of 1.55m to 1.85m is recommended to be 0.3 to 2.5m. Users may slightly move forward or backward to improve the character of facial images captured.

● Recommended Standing Posture and Facial Expression

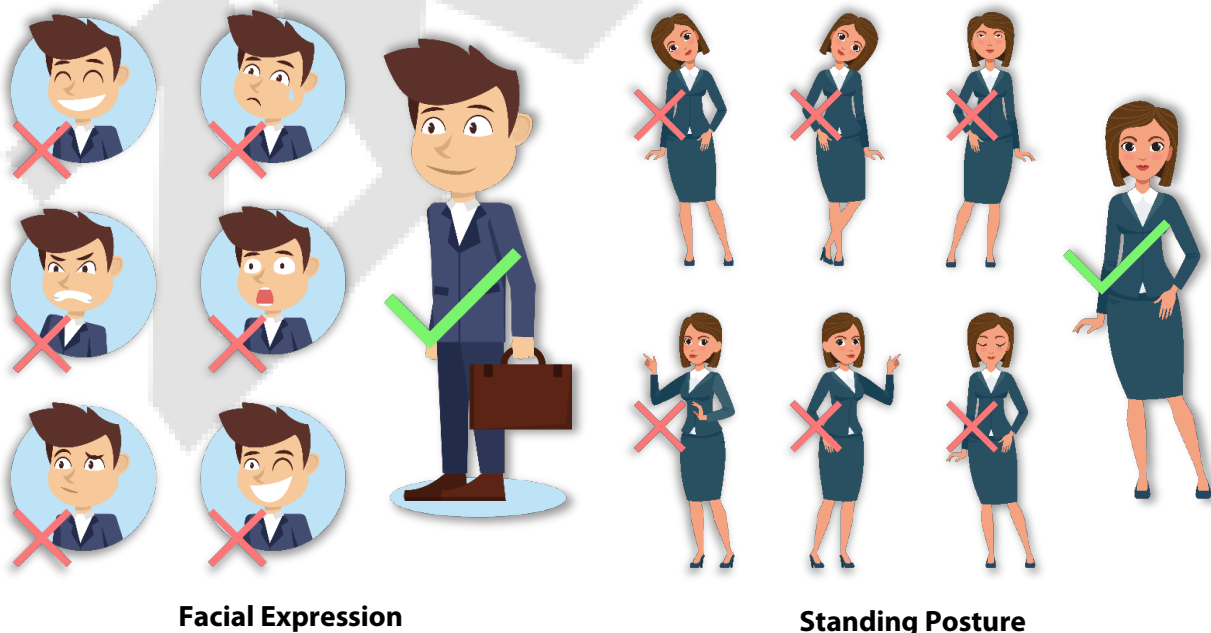

Facial Expression

Standing Posture

Note: Please keep your facial expression and standing posture natural while enrolment or verification.

2.3 Face Registration

Try to keep the face in the centre of the screen during registration. Please face the camera and stay still during face registration. The screen looks like this:

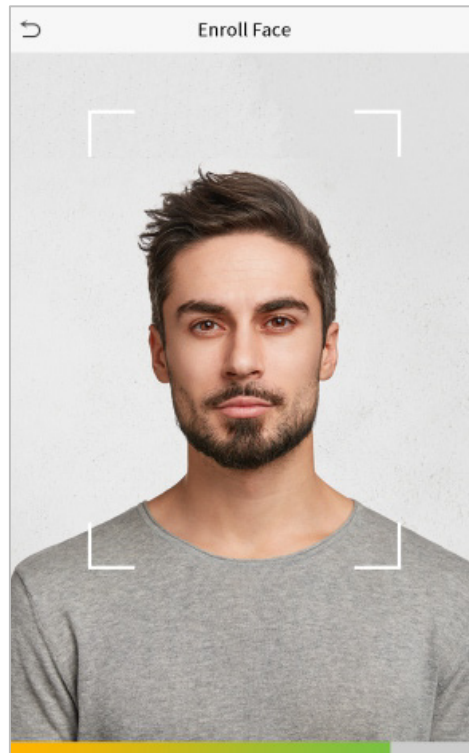

- **Correct Face Registration and Authentication Method**

Recommendation for Registering a Face

- When registering a face, maintain a distance of 40cm to 80cm between the device and the face.
- Be careful to keep your facial expression natural and not to change. (smiling face, drawn face, wink, etc.)
- If you do not follow the instructions on the screen, the face registration may take longer or may fail.
- Be careful not to cover the eyes or eyebrows.
- Do not wear hats, masks, sunglasses or eyeglasses.
- Be careful not to display two faces on the screen. Register one person at a time.
- It is recommended for a user wearing glasses to register both faces with and without glasses.

Recommendation for Authenticating a Face



- Ensure that the face appears inside the guideline displayed on the screen of the device.
- Sometimes, authentication may fail due to the change in the wearing glasses then the one used while registration. In such a case, you may require authenticating your face with the previously worn glasses. If your face was registered without glasses, you should authenticate your face without glasses further.

- If a part of the face is covered with a hat, a mask, an eye patch, or sunglasses, authentication may fail. Do not cover the face, allow the device to recognize both the eyebrows and the face.

2.4 Standby Interface

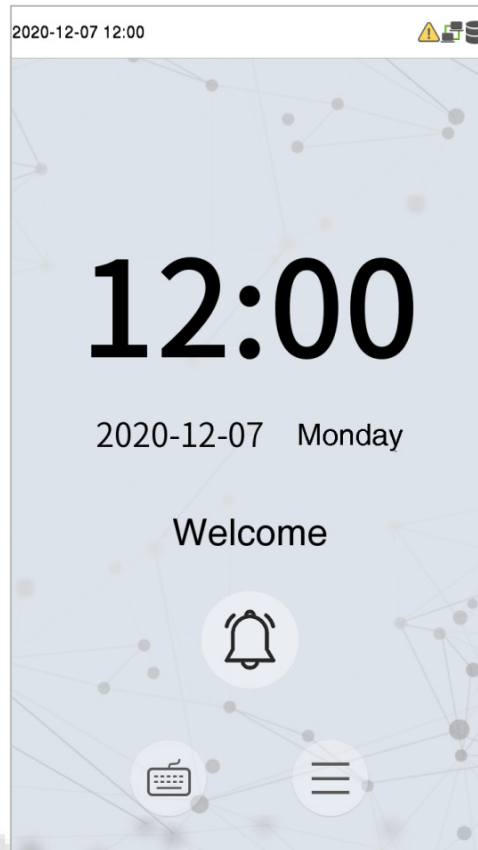
After connecting the power supply, the following standby interface is displayed:



- Tap  to enter the User ID input interface.
- When there is no Super Administrator set in the device, tap  to go to the menu.
- After adding a Super Administrator on the device, it requires the Super Administrator's verification before opening the menu functions.

Note: For the security of the device, it is recommended to register a super administrator the first time you use the device.

- The punch state options can also be displayed and used directly on the standby interface. Tap anywhere on the screen apart from the icons, and six shortcut keys appears on the screen, as shown in the figure below:

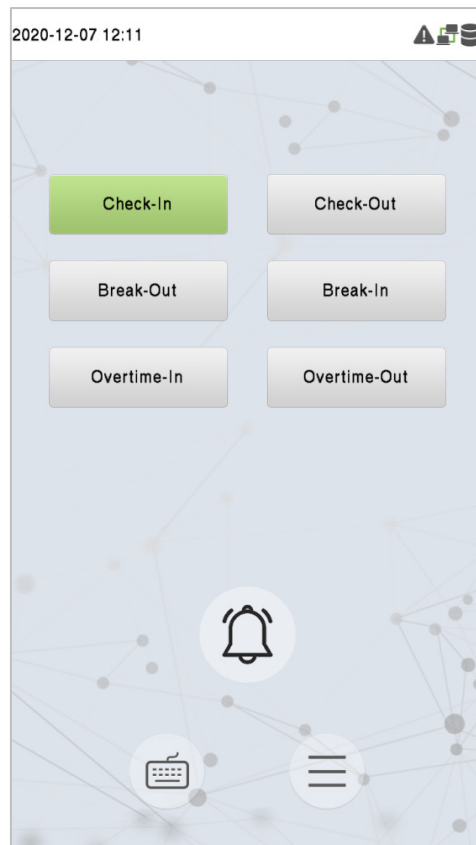

- Press the corresponding punch state key to select your current punch state, which is displayed in green. Please refer to "[Shortcut Key Mappings](#)" for the specific operation method.

Note: The punch state options are off by default and need to select other mode options in the "[Punch States Options](#)" to get the punch state options on the standby screen.

2.5 Virtual Keyboard

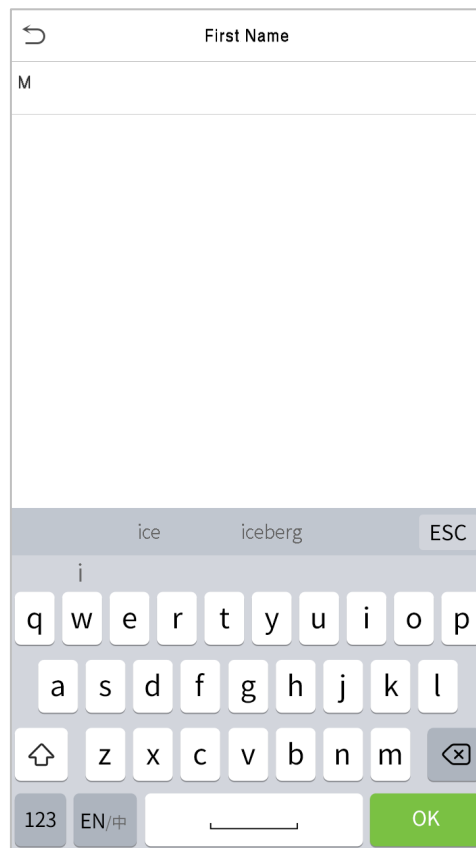

Note: The device supports the input in Chinese language, English language, numbers, and symbols.

- Tap **En** to switch to the English keyboard.
- Press **123** to switch to the numeric and symbolic keyboard.
- Tap **ABC** to return to the alphabetic keyboard.
- Tap the input box, a virtual keyboard appears.
- Tap **ESC** to exit the virtual keyboard.

2.6 Verification Mode

2.6.1 Fingerprint Verification

- **1: N Fingerprint Verification Mode**

Compares the fingerprint that is being pressed onto the fingerprint reader with all of the fingerprint data that is stored in the device.

The device enters the fingerprint authentication mode when a user presses his/her finger onto the fingerprint scanner.

Please follow the correct way to place your finger onto the sensor. For details, please refer to section Finger Positioning.

Verification is successful:

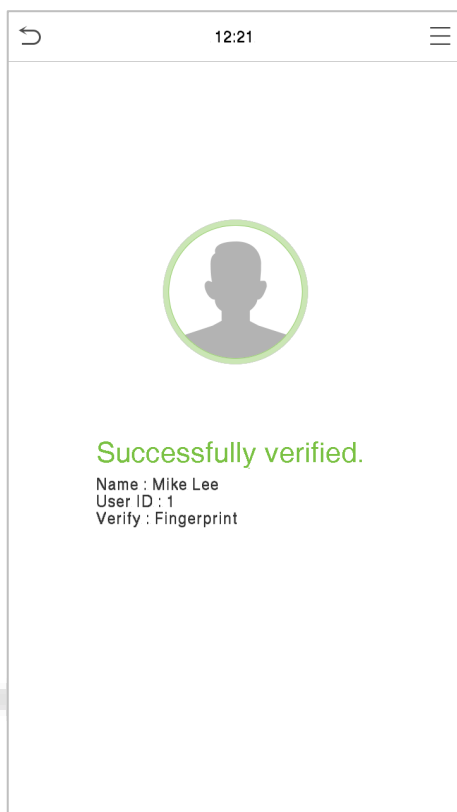

Verification is failed:

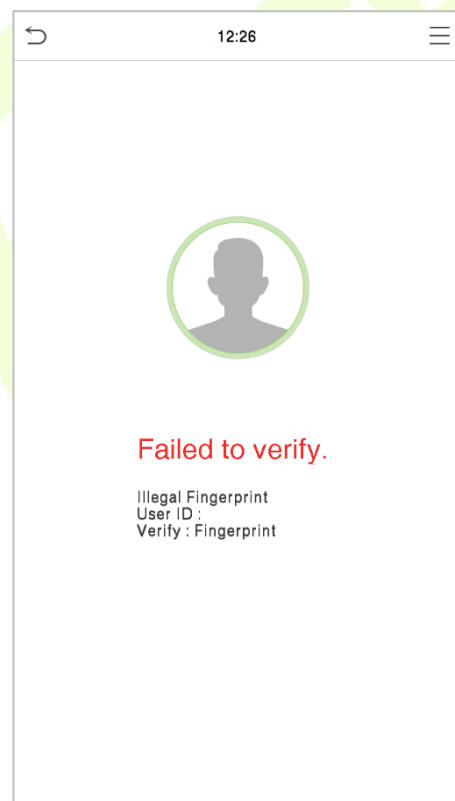

- **1: 1 Fingerprint Verification Mode**

Compares the fingerprint that is being pressed onto the fingerprint reader with the fingerprints that are linked to User ID input via the virtual keyboard.

Users may verify their identities with 1:1 verification mode when they cannot gain access with 1: N authentication method.

Click the  button on the main screen to enter 1:1 fingerprint verification mode.

Input the user ID and press **OK**.

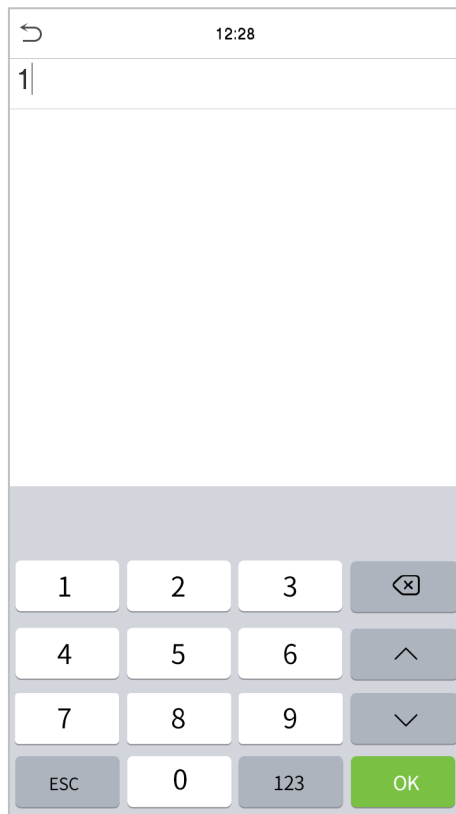

If the user has registered face and password in addition to his/her fingerprints and the verification method is set to Password/Fingerprint/Face verification, the following screen will appear. Select the fingerprint

icon to  enter fingerprint verification mode.

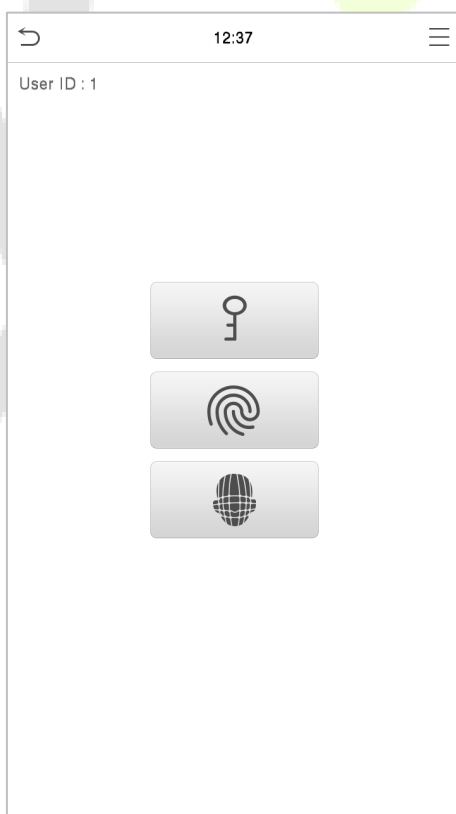

Press the fingerprint to verify.

Verification is successful:

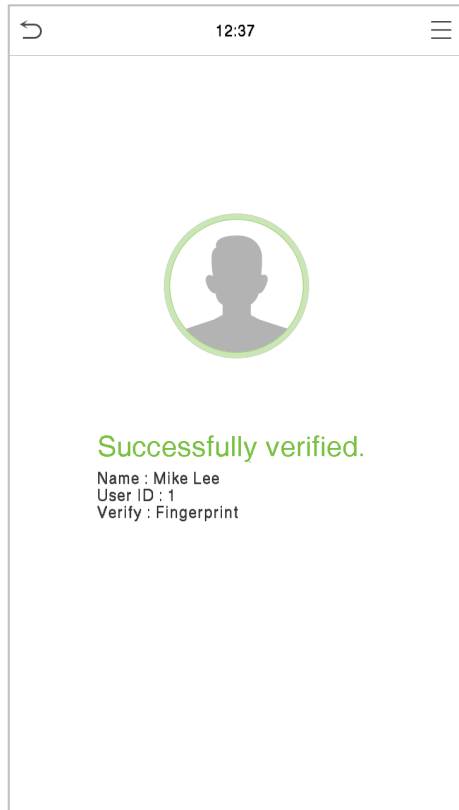

Verification is failed:

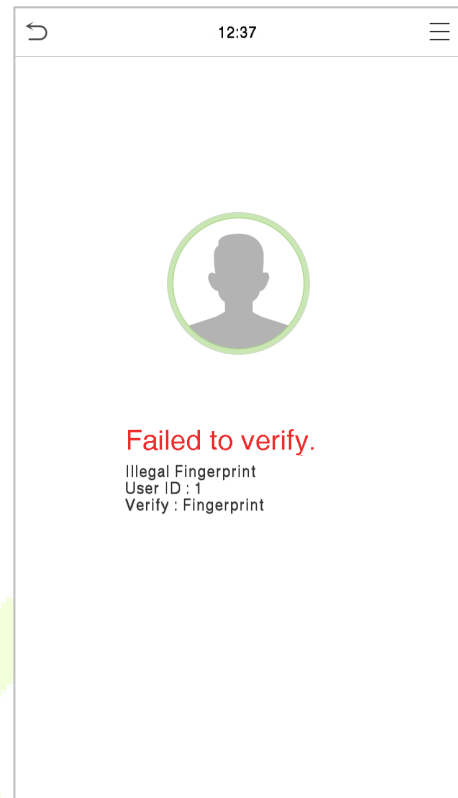

2.6.2 Card Verification

● 1:N Card Verification

It compares the acquired card information with all card data registered in the device. The following is the pop-up prompt box of comparison results.

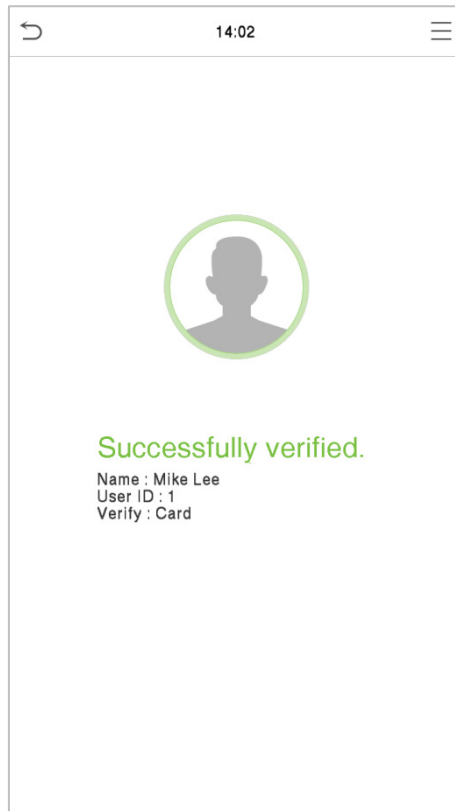

● 1:1 Card Verification

Compares the card that is being put onto the card reader with the card data that related to the entered user ID.

Press  on the main interface and enter the 1:1 card verification mode.

Enter the user ID and click **OK**.

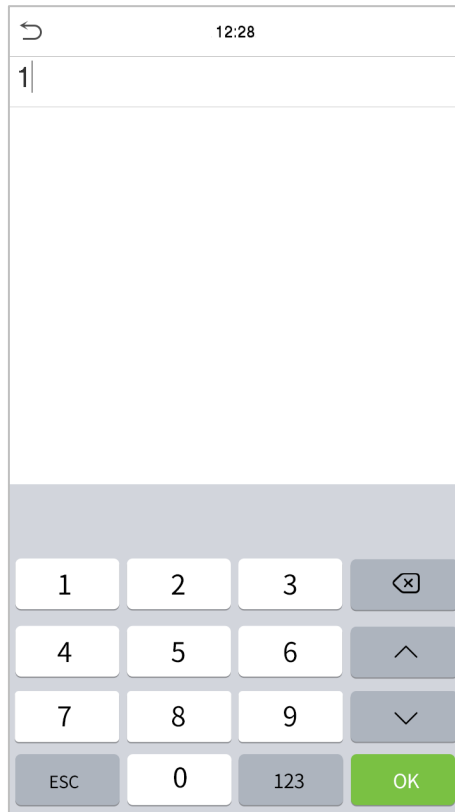

If an employee registers a fingerprint in addition to the card, the following screen will appear. Select the

 icon to enter card verification mode.



Following are the display screen after putting a correct card and a wrong card respectively.

Verification is successful:

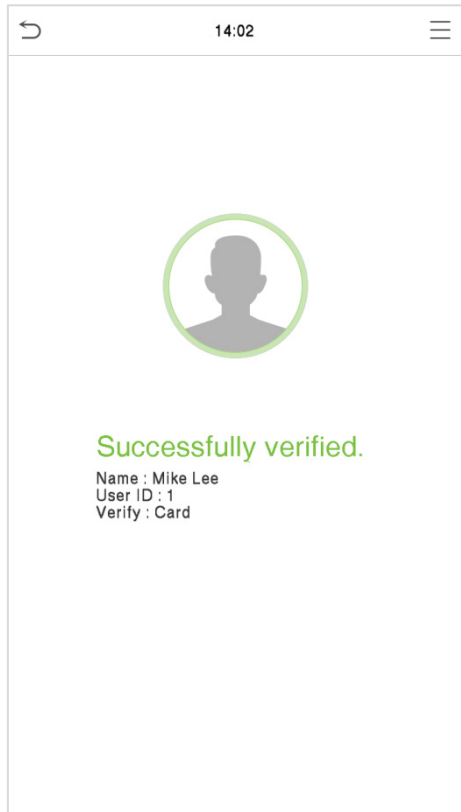

Verification is failed:

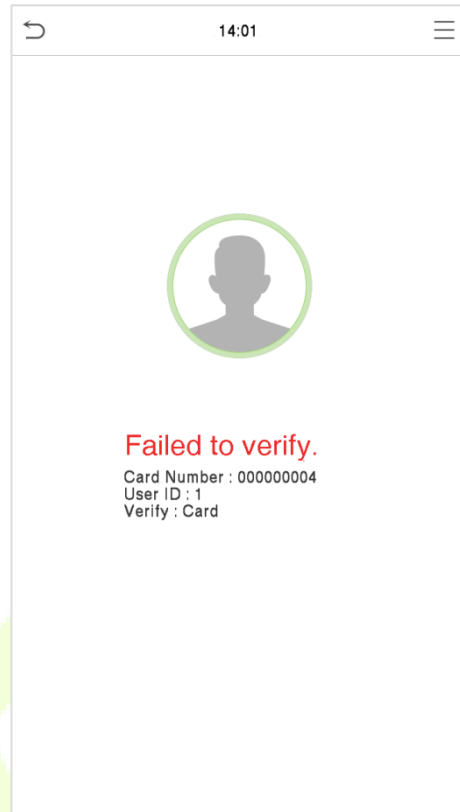

2.6.3 Facial Verification

- **1:N Facial Verification**

Conventional Verification

In this verification mode, the device compares the collected facial images with all face data registered in the device. The following is the pop-up prompt of a successful comparison result.

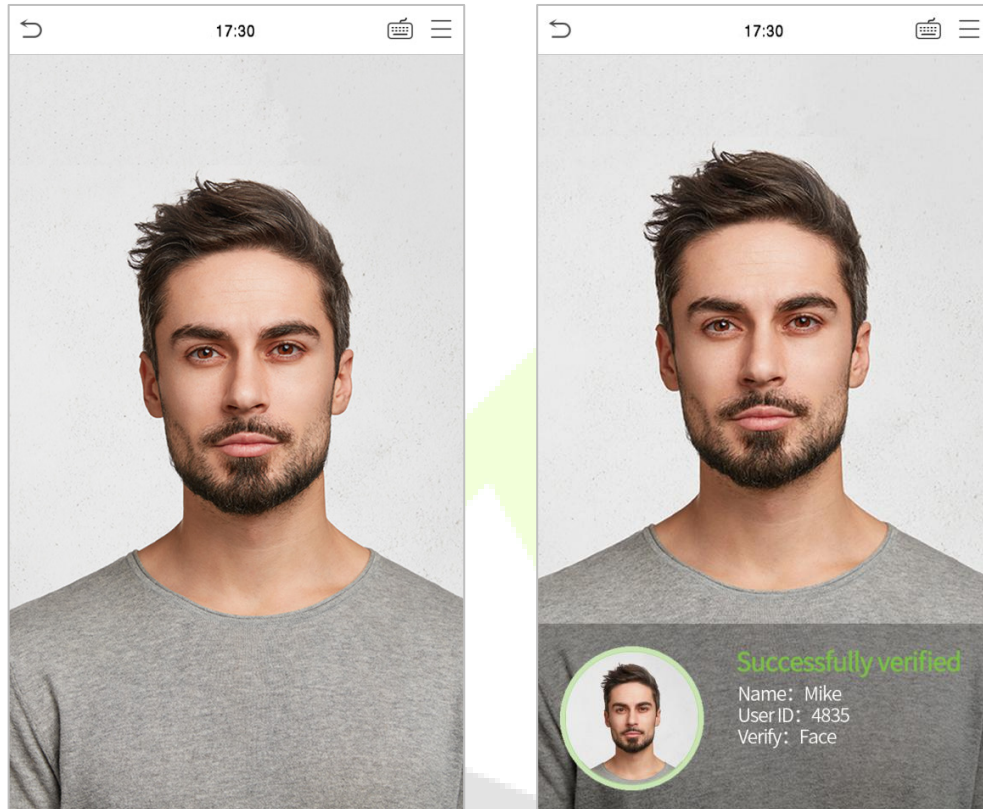

Enable Temperature Screening with Infrared

When the user enables the **Enable temperature screening with infrared** function, during user verification, in addition to the conventional verification method, the user's face must be aligned with the temperature measurement area to measure the body temperature before the verification can be conducted. The following are the popups of the comparison result prompt interface. (Note: This function is only applicable to products with temperature measurement module.)

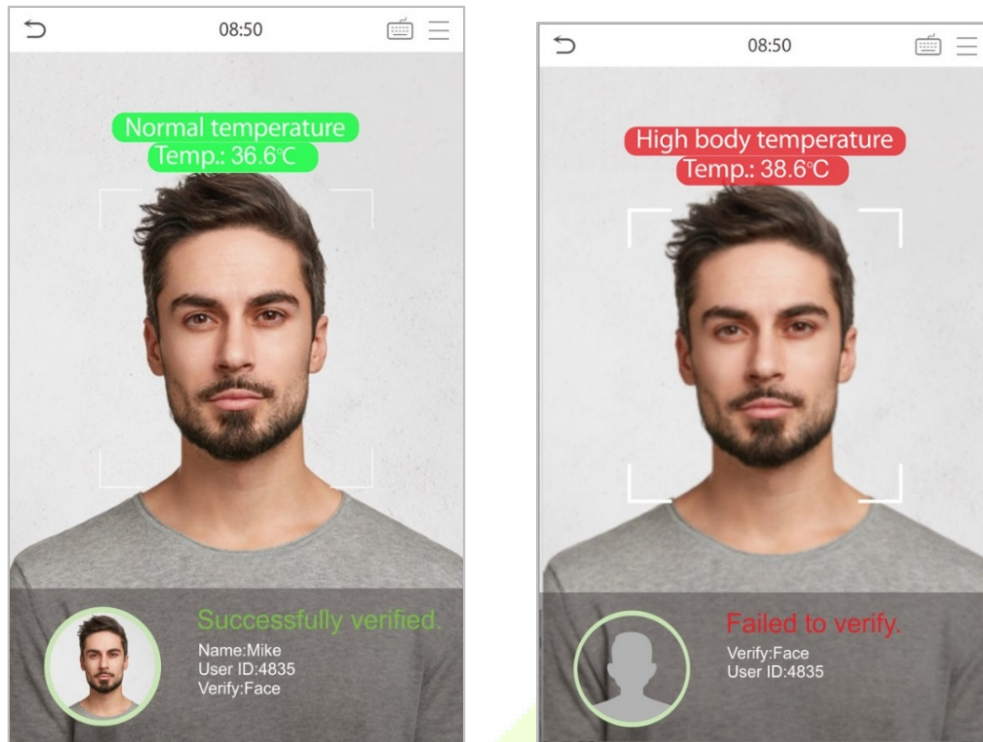

Enable Mask Detection

When the user enables the **Enable mask detection** function, the device will identify whether the user is wearing a mask or not while verification. The following are the popups of the comparison result prompt interface. (Note: This function is only applicable to products with temperature measurement module.)



Display Thermodynamics Figure

When the user enables the **Display Thermodynamics Figure** function, the thermal image of the person is displayed in the upper left corner of the device, while verification. As shown in the images below:

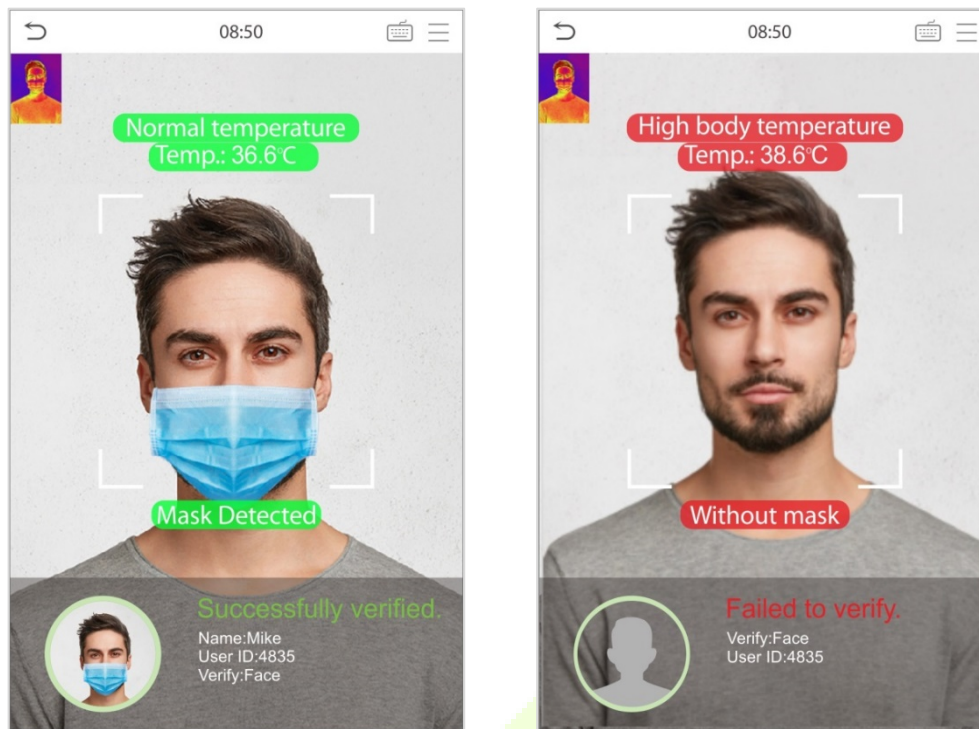



● 1:1 Facial Verification

Compare the face captured by the camera with the facial template related to the entered user ID.

Press  on the main interface and enter the 1:1 facial verification mode.

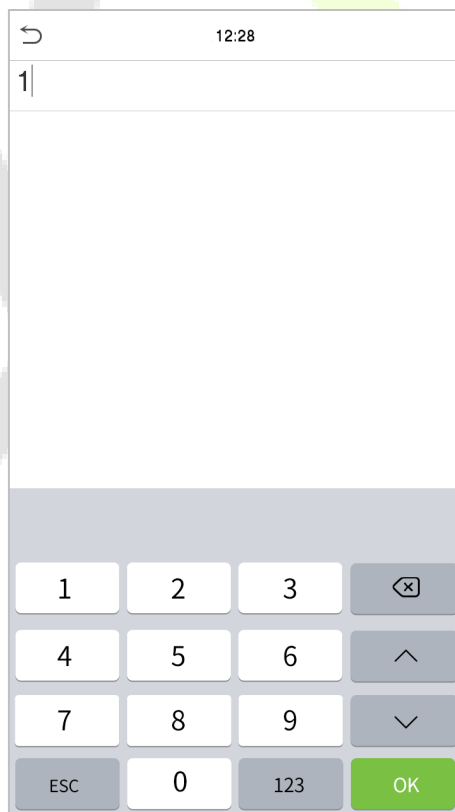
Enter the user ID and click **OK**.



If an employee registers a fingerprint and password in addition to the face, the following screen will appear. Select the  icon to enter face verification mode.



After successful verification, the prompt box displays "**Successfully Verified**", as shown below:



If the verification is failed, it prompts "**Please adjust your position!**".

2.6.4 Password Verification

The device compares the entered password with the registered password of the given User ID.

Tap the  button on the main screen to enter the 1:1 password verification mode. Then, input the user ID and press **OK**.

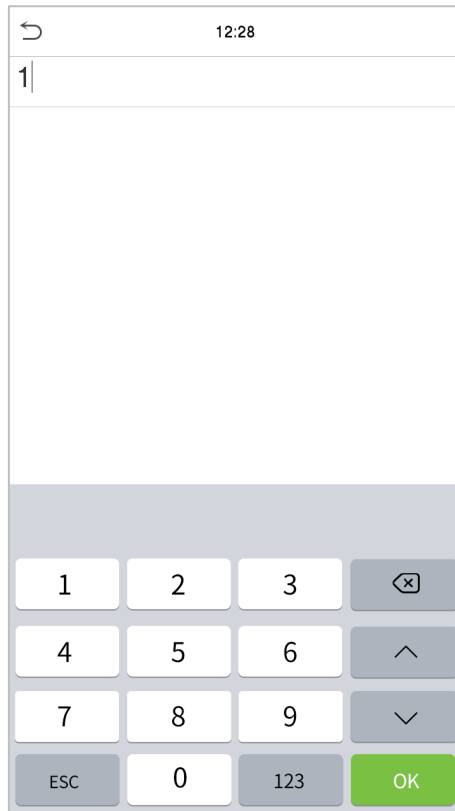

If an employee registers fingerprint and face in addition to password, the following screen will appear.

Select the  icon to enter password verification mode.



Input the password and press **OK**.

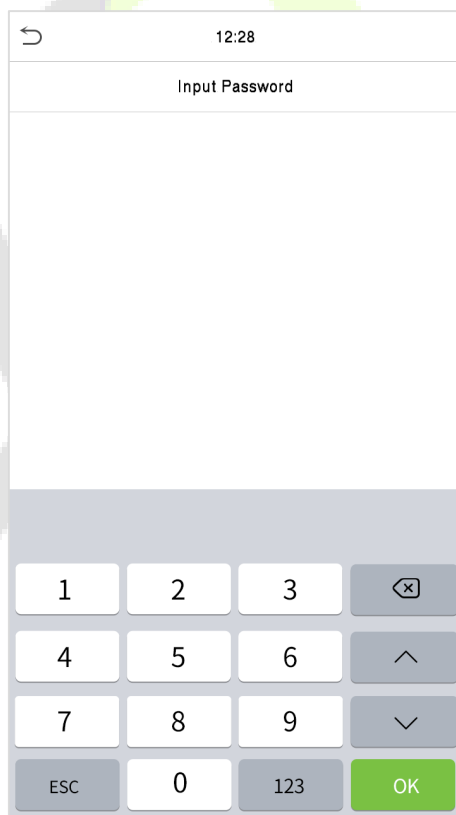

Following are the display screen after entering a correct password and a wrong password respectively.

Verification is successful:

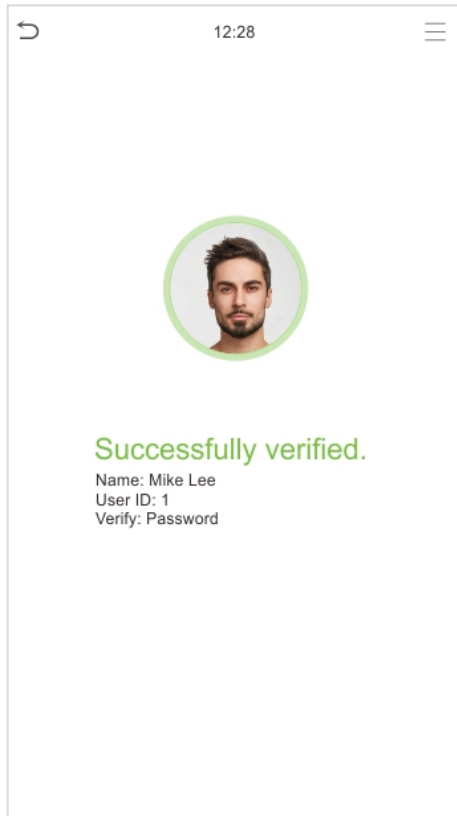

Verification is failed:

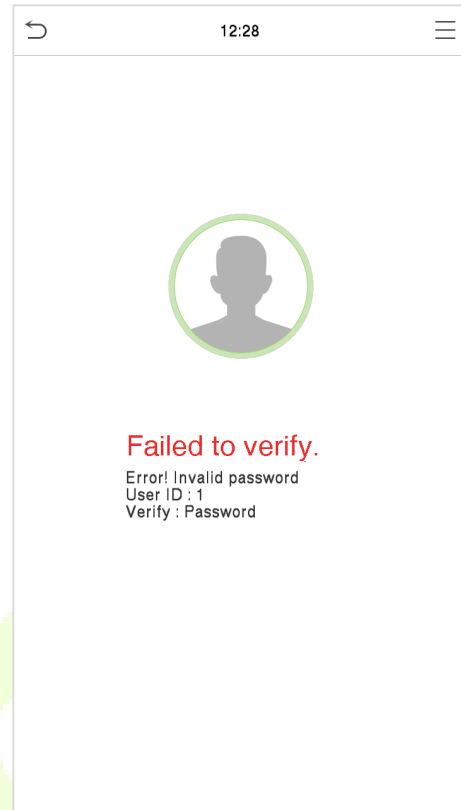

2.6.5 Combined Verification

To increase security, this device offers the option of using multiple forms of verification methods.

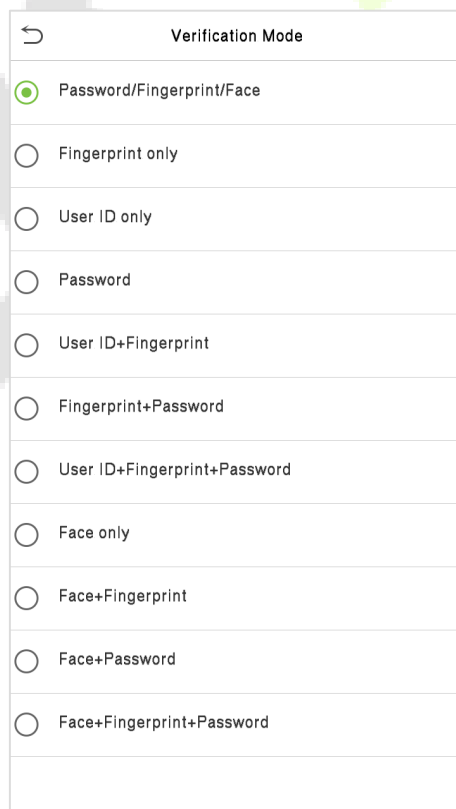

Procedure to Set for Combined Verification Mode

- Combined verification requires personnel to register all the different verification methods. Otherwise, employees may not be able to successfully verify through the combined verification process.
- For instance, when an employee has registered only the face data, but the Device verification mode is set as "**Face + Password**", the employee will not be able to complete the verification process successfully.
- This is because the Device compares the scanned face template of the person with registered verification template (both the Face and the Password) previously stored to that Personnel ID in the Device.

But as the employee has registered only the Face but not the Password, the verification will not get completed and the Device displays "**Verification Failed**".

Note:

- "/" means "**or**", and "+" means "**and**".
- You must register the required verification information before using the combination verification mode, otherwise the verification may fail. For example, if a user uses Face Registration but the verification mode is Face + Password, this user will never pass verification.

3 Main Menu

Press  on the initial interface to enter the main menu, as shown below:

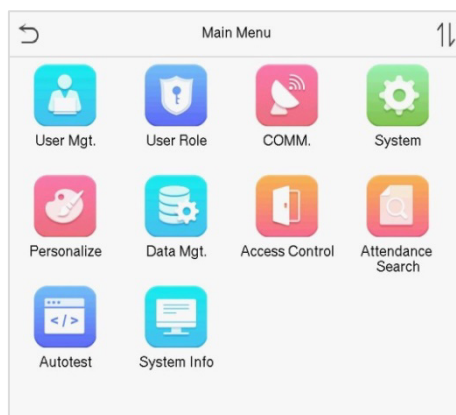

Function Description

Menu	Descriptions
User Mgt.	To Add, Edit, View, and Delete information of a User.
User Role	To set the permission scope of the custom role and enroller for the users, that is, the rights to operate the system.
COMM.	To set the relevant parameters of Network, Serial Comm., PC Connection, Wireless Network, Cloud Server, Wiegand and Network Diagnosis.
System	To set parameters related to the system, including Date & Time, Access Logs Setting, Face, card, password and Fingerprint parameters, Video Intercom parameters, security settings and resetting to factory settings.
Personalize	To customize settings of User Interface, Voice, Bell Schedules, Punch State Options and Shortcut Key Mappings settings.
Data Mgt.	To delete all relevant data in the device.
Access Control	To set the parameters of the lock and the relevant access control device including options like Time schedule, Holiday Settings, Combine verification, Anti-passback Setup, and Duress Option Settings.
Attendance Search	To query the specified Event logs, check Attendance Photos and Blocklist attendance photos.
Autotest	To automatically test whether each module functions properly, including the LCD Screen, Audio, Microphone, Fingerprint sensor, Camera, and Real-Time Clock.
System Info	To view Data Capacity , Device and Firmware information and Privacy Policy of the device.

Note: When users use the product for the first time, they should operate it after setting administrator privileges. Tap **User Mgt.** to add an administrator or edit user permissions as a super administrator. If the

product does not have an administrator setting, the system will show an administrator setting command prompt every time you enter the device menu.

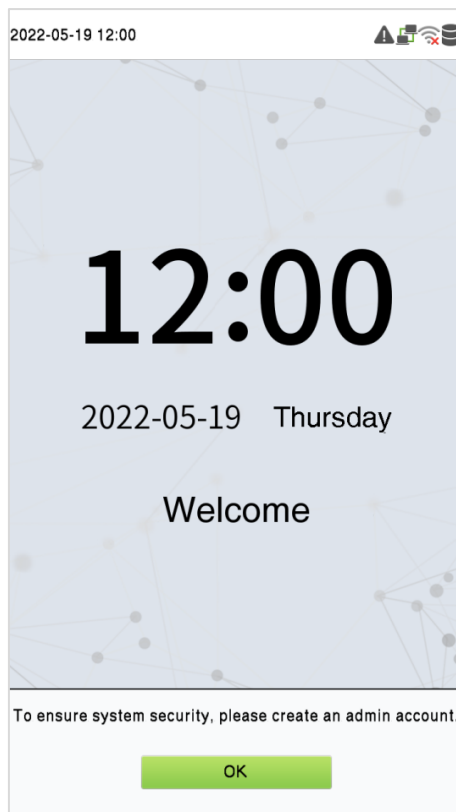

4 User Management

4.1 User Registration

Tap **User Mgt.** on the main menu.

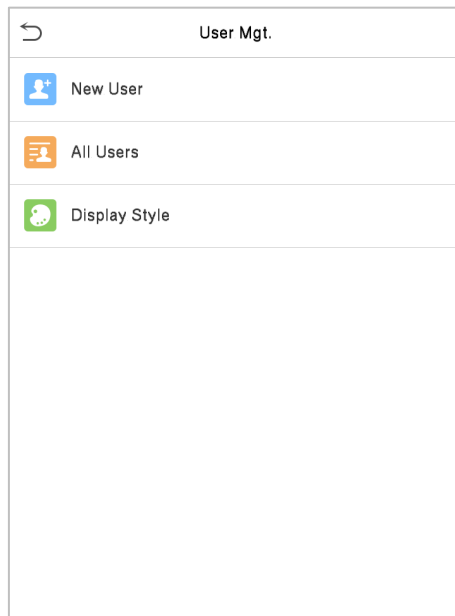

4.1.1 Register a User ID and Name

Tap **New User** and enter the **User ID** and **Name**.

New User	
User ID	3
Name	
User Role	Normal User
Palm	0
Fingerprint	0
Face	0
Card Number	
Password	
Access Control Role	

Note:

- A name can take up to 17 characters.
- The user ID may contain 1-9 digits by default.
- You can modify your ID during the initial registration but not after registration.
- If a message "**Duplicated!**" pops up, you must choose another ID as the entered User ID already exists.

4.1.2 Setting the User Role

There are two types of user accounts: the **Normal User** and the **Super Admin**. If there is already a registered administrator, the normal users have no rights to manage the system and may only access authentication verifications. The administrator owns all management privileges. If a custom role is set, you can also select **User Defined Role** permissions for the user.

Click **User Role** to select Normal User or Super Admin.

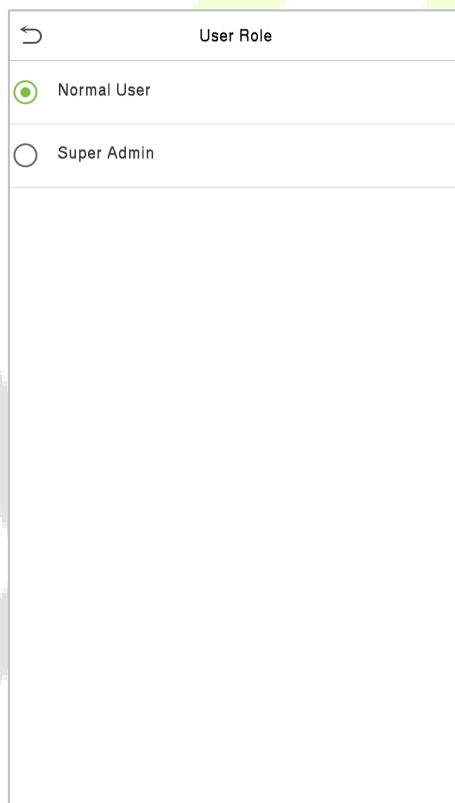

The screenshot shows a mobile application interface for selecting a user role. At the top, there is a back arrow icon and the title "User Role". Below the title, there are two radio button options: "Normal User" (which is selected, indicated by a green dot) and "Super Admin" (which is unselected, indicated by a white dot). The background of the screen is white with a large, faint, light green watermark that reads "ZKTECO".

Note: If the selected user role is the Super Admin, the user must pass the identity authentication to access the main menu. The authentication is based on the authentication method(s) that the super administrator has registered. Please refer to "[Verification Mode](#)".

4.1.3 Register Fingerprint

Click **Fingerprint** to enter the fingerprint registration page. Select the finger to be enrolled.

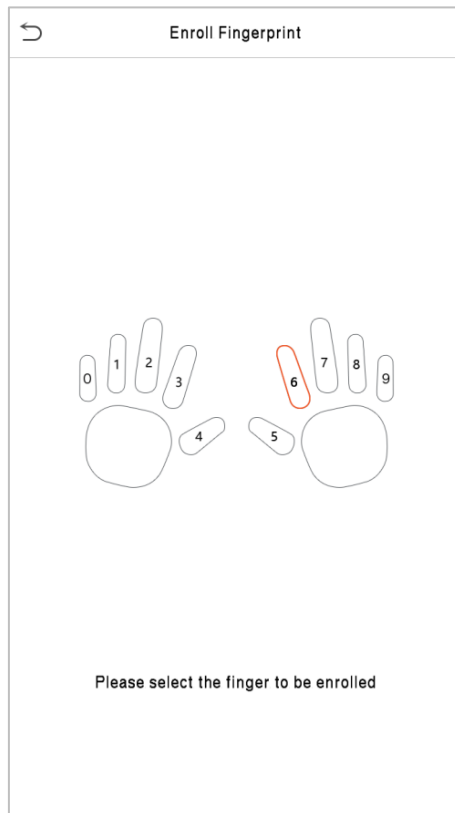

Press the same finger on the fingerprint reader three times. Green indicates that the fingerprint was enrolled successfully.

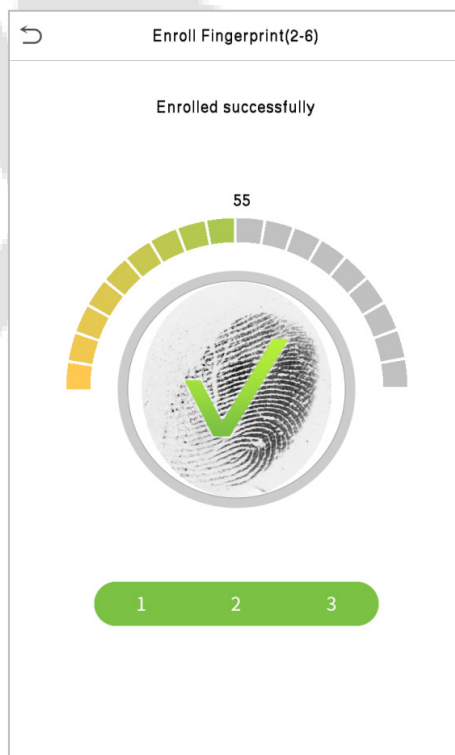

4.1.4 Register Face

Click **Face** to enter the face registration page. Please face the camera and stay still during face registration. The registration interface is as follows:



4.1.5 Register Card Number

● Enroll Card

Tap **Card** in the **New User** interface to enter the card registration page.

- On the Card interface, swiping card underneath the card reading area. The card registration will be successful.
- If the card is registered already then the **“Duplicate Card”** message shows up. The registration interface is as follows:

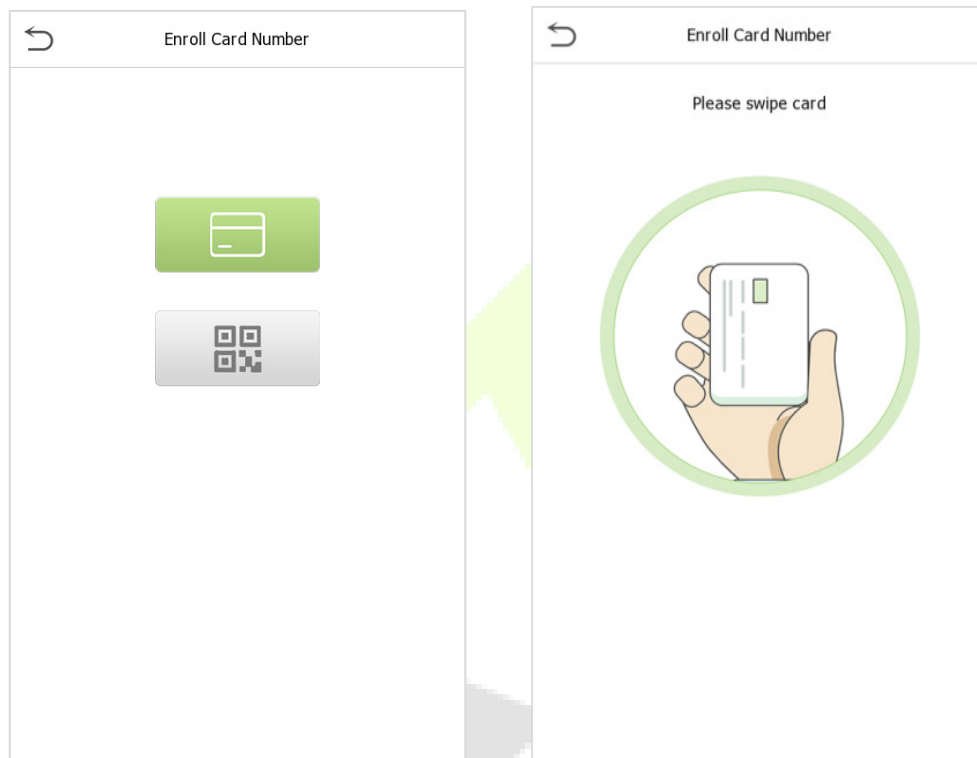

● Enroll Card QR Code

Tap **Card** in the **New User** interface to enter the card registration page.

- On the Card interface, show the QR code in front of the camera. The QR code registration will be successful.
- If the QR code is registered already then the **“Error! Card already enrolled.”** message shows up. The registration interface is as follows:

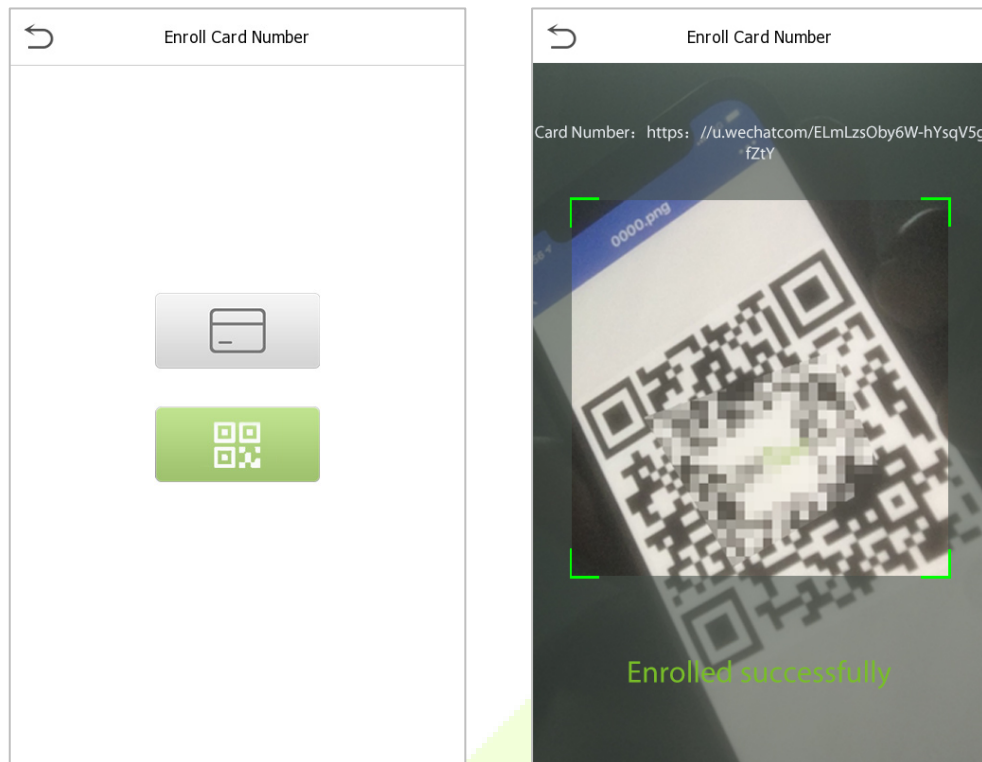

4.1.6 Register Password

Tap **Password** to enter the password registration page. Enter a password and re-enter it. Tap **OK**. If the two entered passwords are different, the prompt "**Password not match!**" will appear.

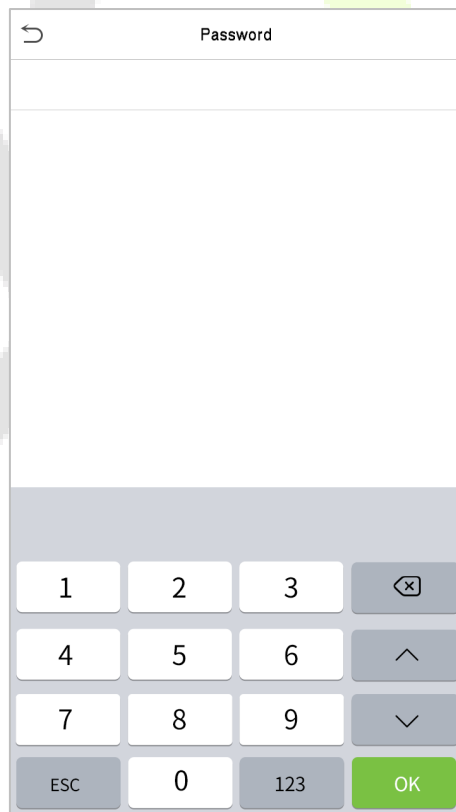

Note: The password may contain one to eight digits by default.

4.1.7 Register User Photo

When a user registered with a photo passes the authentication, the registered photo will be displayed.

Click **User Photo**, click the camera icon to take a photo. The system will return to the **New User** interface after taking a photo.

Note: While registering a face, the system will automatically capture a picture as the user photo. If you do not want to register a user photo, the system will automatically set the picture captured as the default photo.

4.1.8 Access Control Role

User access control sets the door unlocking rights of each person, including the group and the time period that the user belongs to.

Click **Access Control Role > Access Group**, assign the registered users to different groups for better management. New users belong to Group 1 by default and can be reassigned to other groups. The device supports up to 99 access control groups.

Click **Time Period**, select the time period to use.

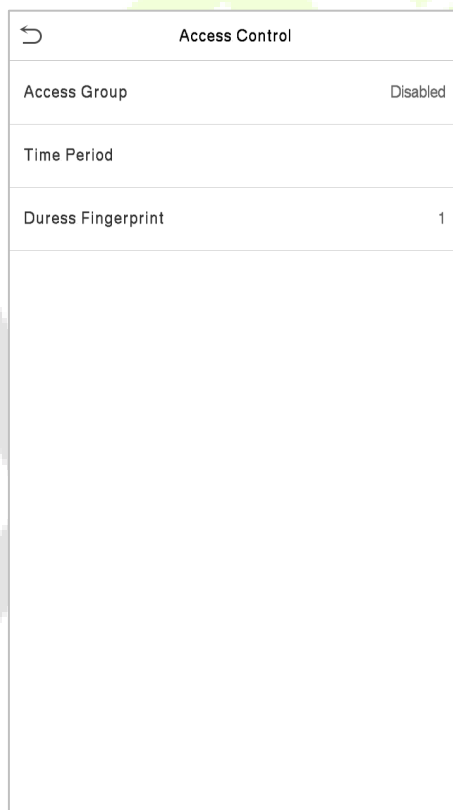

Access Control	
Access Group	Disabled
Time Period	
Duress Fingerprint	1

4.2 Search User

On the **Main Menu**, tap **User Mgt.**, and then tap **All Users** to search a User.

On the **All Users** interface, tap on the search bar on the user's list to enter the required retrieval keyword (where the keyword may be the user ID, surname, or full name) and the system will search for the related user information.

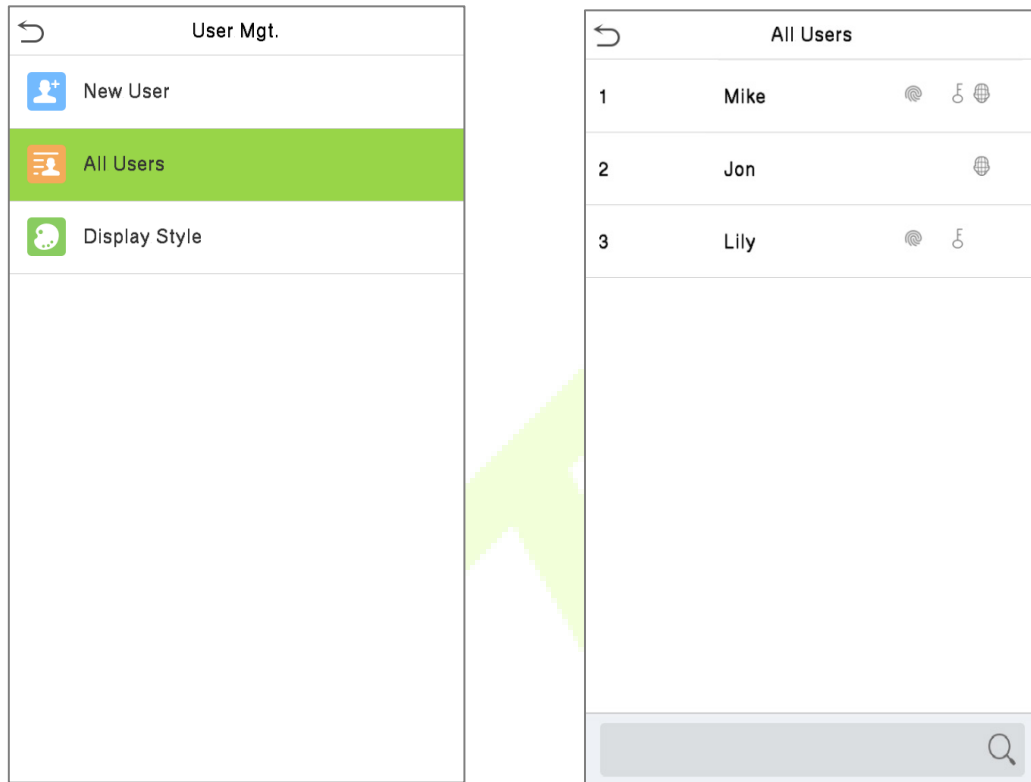

4.3 Edit User

On the **All Users** interface, tap on the required user from the list and tap **Edit** to edit the user information.

User : 1 Mike Lee	
Edit	
Delete	

Edit : 2	
User ID	2
Name	
User Role	Normal User
Palm	1
Fingerprint	1
Face	1
Card Number	
Password	*****
Access Control Role	

Note: The process of editing the user information is the same as adding a new user, except that the User ID cannot be modified when editing a user. The process in detail refers to "[User Registration](#)".

4.4 Deleting User

On the **All Users** interface, tap on the required user from the list and tap **Delete** to delete the user or specific user information from the device. On the **Delete** interface, tap on the required operation and then tap **OK** to confirm the deletion.

- **Delete Operations**

Delete User: Deletes all the user information (deletes the selected User as a whole) from the Device.

Delete Face Only: Deletes the Face information of the selected user.

Delete Password Only: Deletes the password information of the selected user.

Delete Fingerprint Only: Deletes the Fingerprint information of the selected user.

Note: If you select **Delete User**, all information of the user will be deleted.

4.5 Display Style

Tap on **User Mgt.** > **Display Style** to choose the style of **All Users** interface's list.

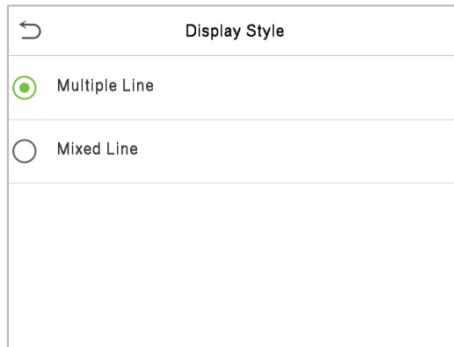

Different display styles are shown as below:

Multiple Line:

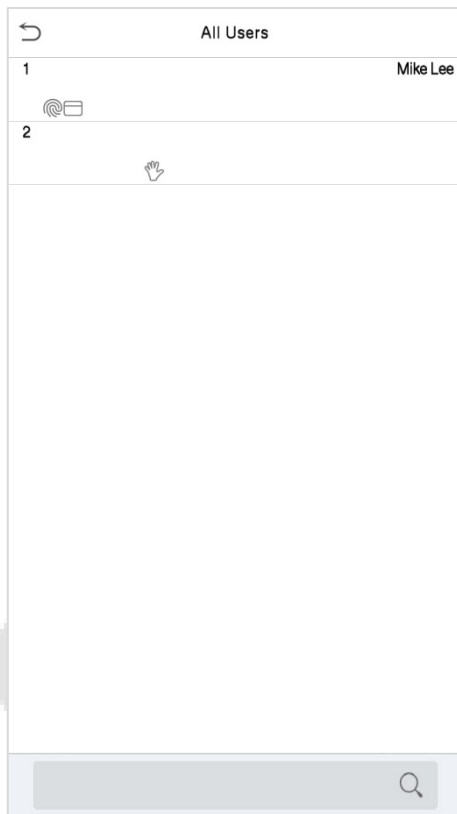

Mixed Line:

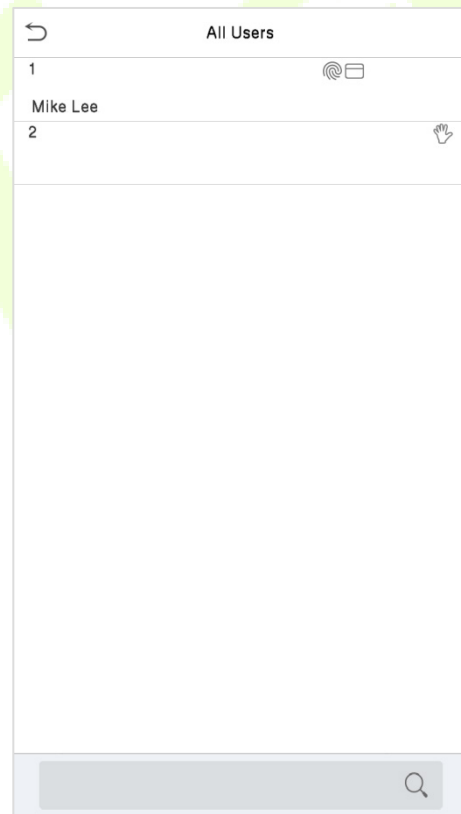

5 User Role

If you need to assign some specific permissions to certain users, you may edit the "User Defined Role" under the **User Role** menu.

You may set the permission scope of the custom role (up to 3 roles) and enroller, that is, the permission scope of the operation menu.

Click **User Role** on the main menu interface.

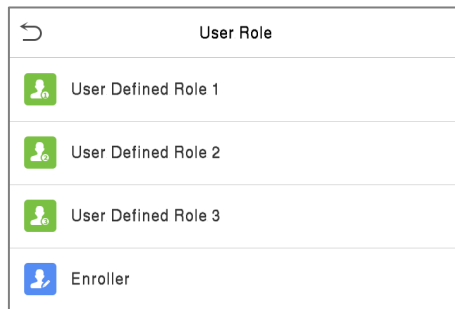

On the **User Defined Role** interface, toggle **Enable Defined Role** to enable or disable the user-defined role.

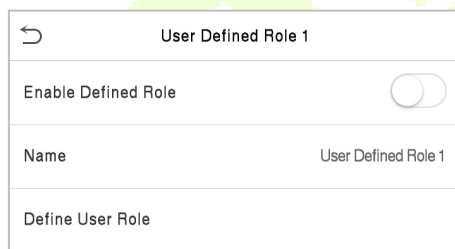

Tap on **Name** and enter the custom name of the role.

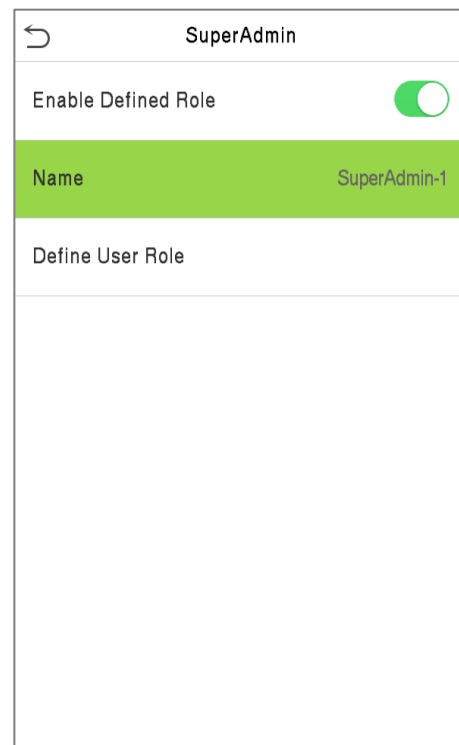
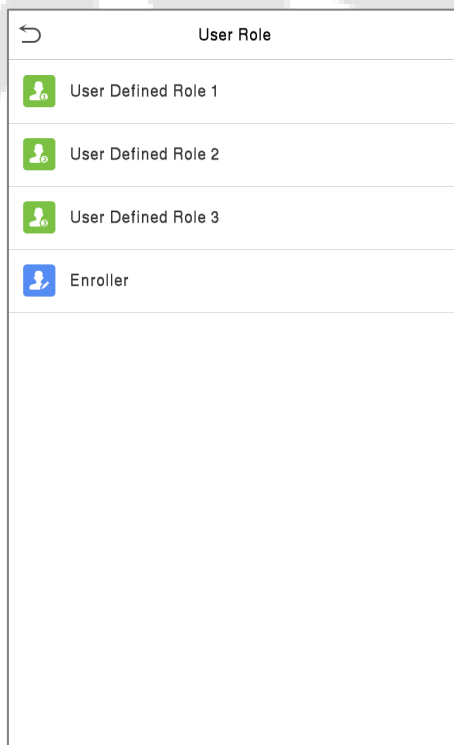

Then, tap on **Define User Role** and select the required privileges to assign to the new role, and then tap on the **Return** button.

During privilege assignment, the **Main Menu** function names will be displayed on the left and its sub-menus will be listed on its right.

First, tap on the required **Main Menu** functions, and then select its required sub-menus from the list which the user can access.

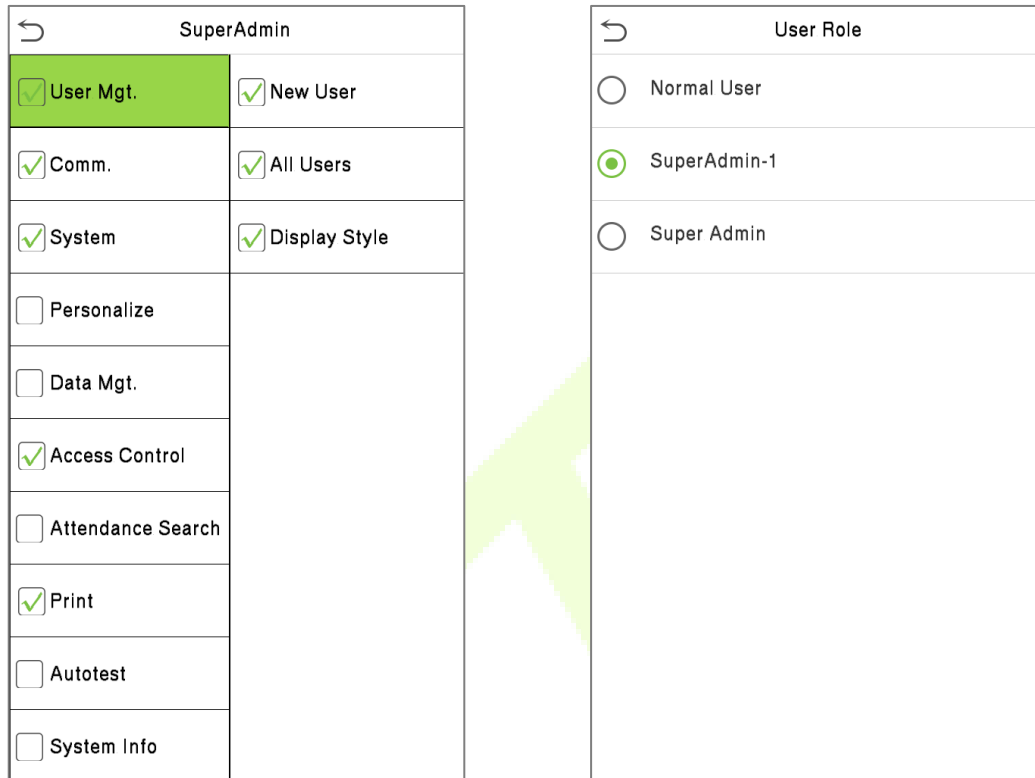

Note: If the User Role is enabled for the device, tap on **User Mgt. > New User > User Role** to assign the created roles to the required users. But if there is no super administrator registered in the device, then the device will prompt "**Please enroll super admin first!**" when enabling the User Role function.

6 Communication Settings

Tap **COMM.** on the **Main Menu** to set the Ethernet PC connection, Cloud Server setting, Wiegand and Network Diagnosis.

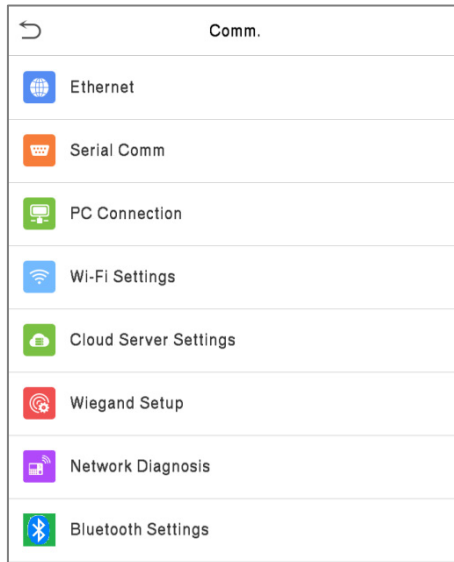

6.1 Network Settings

When the device needs to communicate with a PC over the Ethernet, you need to configure network settings and ensure that the device and the PC connect to the same network segment.

Tap **Ethernet** on the **Comm.** Settings interface to configure the settings.

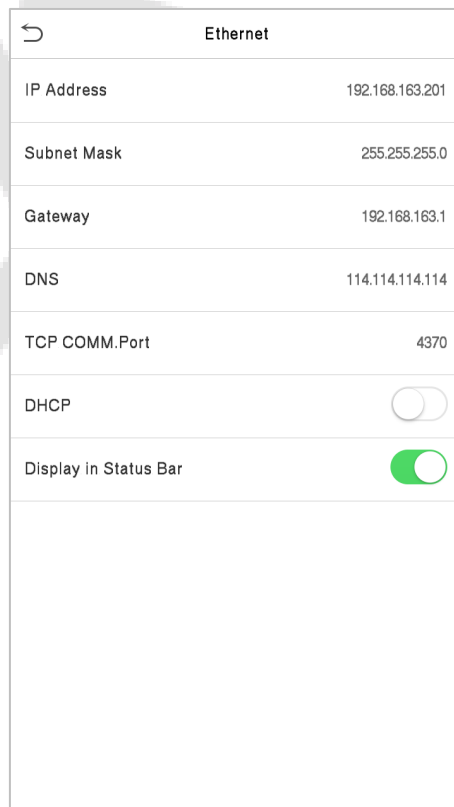

Function Description

Function Name	Descriptions
IP Address	The default IP address is 192.168.1.201. It can be modified according to the network availability.
Subnet Mask	The default Subnet Mask is 255.255.255.0. It can be modified according to the network availability.
Gateway	The default Gateway address is 0.0.0.0. It can be modified according to the network availability.
DNS	The default DNS address is 0.0.0.0. It can be modified according to the network availability.
TCP COMM. Port	The default TCP COMM Port value is 4370. It can be modified according to the network availability.
DHCP	Dynamic Host Configuration Protocol dynamically allocates IP addresses for clients via server.
Display in Status Bar	Toggle to set whether to display the network icon on the status bar.

6.2 Serial Comm★

Serial Comm function facilitates to establish communication with the device through a serial port (/RS485/Master Unit).

Tap **Serial Comm.** on the **Comm.** Settings interface.

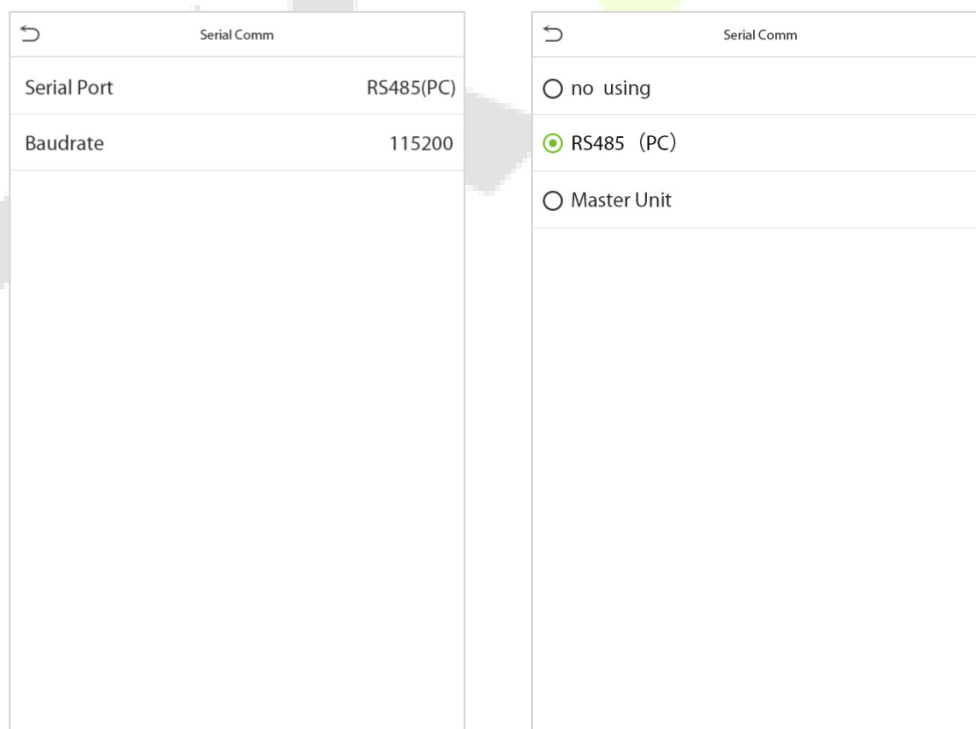

Function Description

Function Name	Descriptions
Serial Port	<p>Disable: Do not communicate with the device through the serial port.</p> <p>RS485(PC): Communicates with the device through RS485 serial port.</p> <p>Master Unit: When RS485 is used as the function of “Master unit”, the device will act as a master unit, and it can be connected to RS485 fingerprint & card reader.</p>
Baud Rate	<p>The rate at which the data is communicated with PC, there are 4 options of baud rate: 115200 (default), 57600, 38400, and 19200.</p> <p>The higher is the baud rate, the faster is the communication speed, but also the less reliable.</p> <p>Hence, a higher baud rate can be used when the communication distance is short; when the communication distance is long, choosing a lower baud rate would be more reliable.</p>

6.3 PC Connection

Comm Key facilitates to improve the security of data by setting the communication between the device and the PC. Once the Comm Key is set, a password is required to connect the device to the PC software.

Tap **PC Connection** on the **Comm.** Settings interface to configure the communication settings.

PC Connection	
Comm Key	*****
Device ID	1

Function Description

Function Name	Descriptions
Comm Key	<p>The default password is 0 and can be changed.</p> <p>The Comm Key can contain 1-6 digits.</p>
Device ID	<p>It is the identification number of the device, which ranges between 1 and 254.</p> <p>If the communication method is RS232/RS485, you need to input this device ID in the software communication interface.</p>

6.4 Wireless Network

The device provides a Wi-Fi module, which can be built-in within the device mould or can be externally connected.

The Wi-Fi module enables data transmission via Wi-Fi (Wireless Fidelity) and establishes a wireless network environment. Wi-Fi is enabled by default in the device. If you don't need to use the Wi-Fi network, you can toggle the Wi-Fi to disable button.

Tap **Wi-Fi Settings** on the **Comm.** Settings interface to configure the WiFi settings.

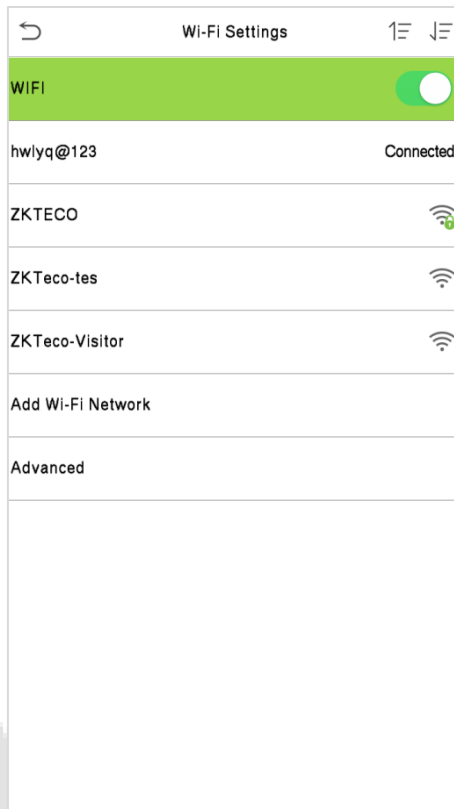

WIFI is enabled in the Device by default. Toggle on  button to enable or disable WIFI.

Once the Wi-Fi is turned on, the device will search for the available WIFI within the network range.

Tap on the appropriate WiFi name from the available list, and input the correct password in the password interface, and then tap **Connect to WIFI (OK)**.

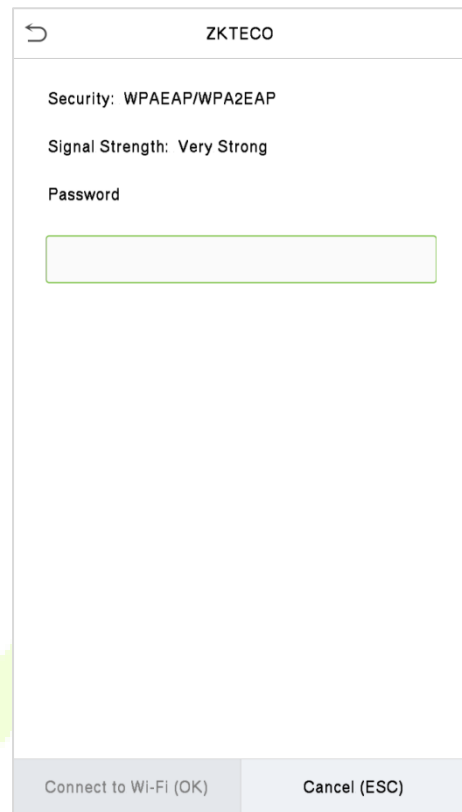
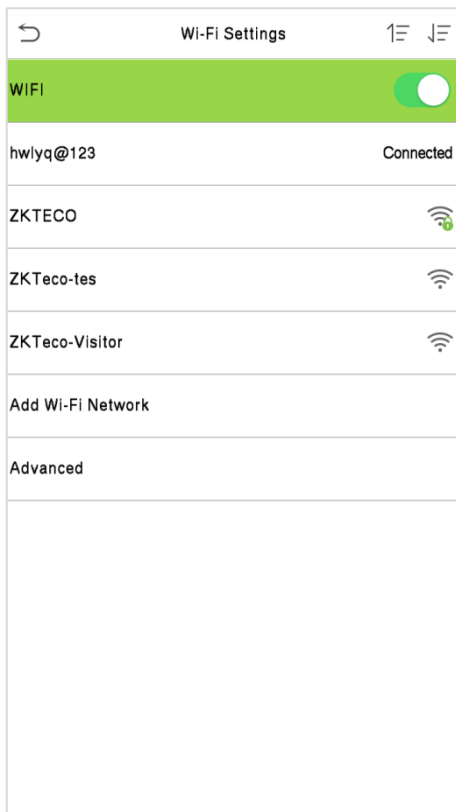

WIFI Enabled: Tap on the required network from the searched network list.

Tap on the password field to enter the password, and then tap on **Connect to WIFI (OK)**.

When the WIFI is connected successfully, the initial interface will display the Wi-Fi  logo.

● Add WIFI Network Manually

The WIFI can also be added manually if the required WIFI is not displayed on the list.

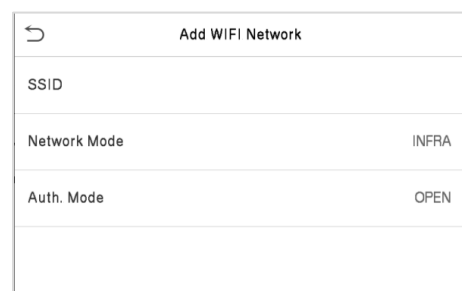

Tap on **Add WIFI Network** to add the WIFI manually.

On this interface, enter the WIFI network parameters. (The added network must exist.)

Note: After successfully adding the WIFI manually, follow the same process to search for the added WIFI name.

● Advanced Setting

On the **Wireless Network** interface, tap on **Advanced** to set the relevant parameters as required.

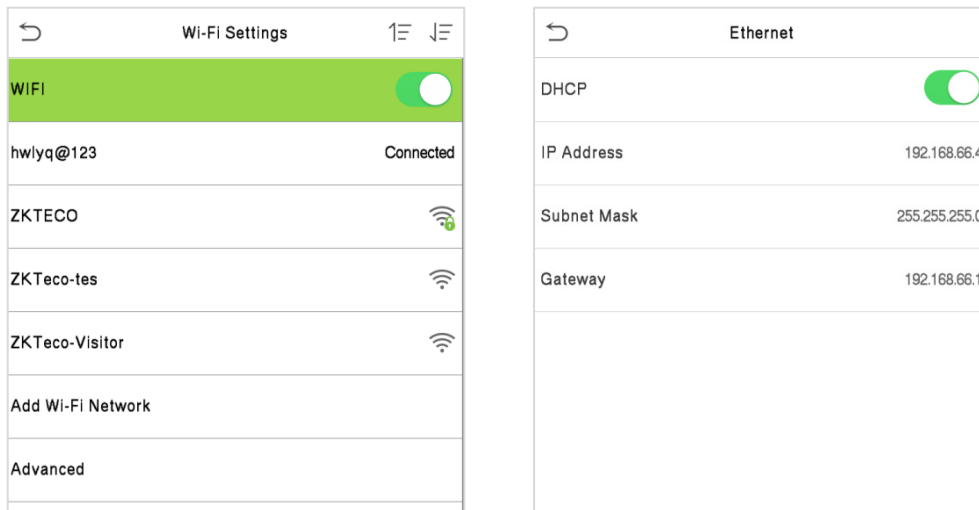

Function Description

Function Name	Description
DHCP	Dynamic Host Configuration Protocol (DHCP) dynamically allocates IP addresses to network clients. If the DHCP is enabled, then the IP cannot be set manually.
IP Address	IP address for the WIFI network, the default is 0.0.0.0. It can be modified according to the network availability.
Subnet Mask	The default Subnet Mask of the WIFI network is 255.255.255.0. It can be modified according to the network availability.
Gateway	The default Gateway address is 0.0.0.0. Can be modified according to the network availability.

6.5 Cloud Server Setting

Tap **Cloud Server Setting** on the **Comm.** Settings interface to connect with the ADMS server.

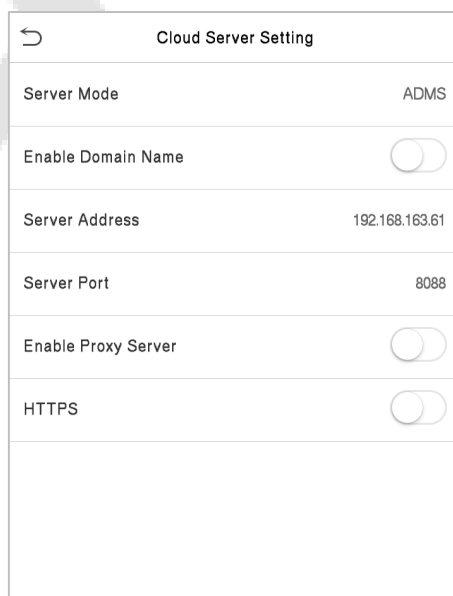

Function Description

Function Name		Description
Enable Domain Name	Server Address	Once this mode is turned ON , the domain name mode "http://..." will be used, such as http://www.XYZ.com, while "XYZ" denotes the domain name.
Disable Domain Name	Server Address	The IP address of the ADMS server.
	Server Port	Port used by the ADMS server.
Enable Proxy Server		The IP address and the port number of the proxy server is set manually when the proxy is enabled.
HTTPS		To increase the security of browser access, users can enable the HTTPS protocol to create a secure and encrypted network transmission and assure the security of sent data through identity authentication and encrypted communication. This function is enabled by default. This function can be enabled or disabled through the menu interface, and when changing the HTTPS status, the device will pop up a security prompt, and restart after confirmation.

6.6 Wiegand Setup

It is used to set the Wiegand input and output parameters.

Tap **Wiegand Setup** on the **Comm.** Settings interface to set the Wiegand input and output parameters.

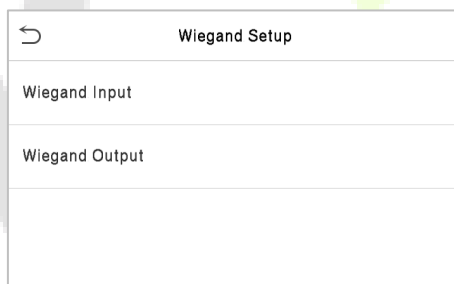

Wiegand Setup	
Wiegand Input	
Wiegand Output	

6.6.1 Wiegand Input

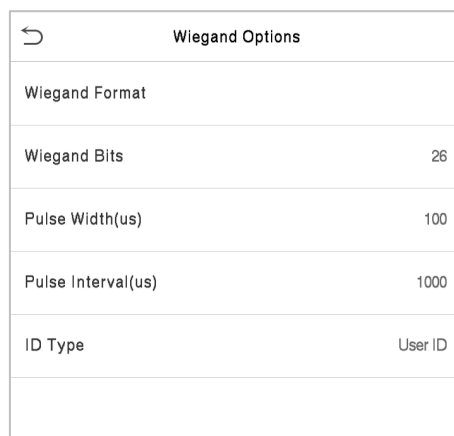

Wiegand Options	
Wiegand Format	
Wiegand Bits	26
Pulse Width(us)	100
Pulse Interval(us)	1000
ID Type	User ID

<p>Wiegand37a</p>	<p>EMMMFFFFFFFFSSSSSSCCCCCCCCCCCCCCCCCCO</p> <p>It consists of 37 bits of binary code. The 1st bit is the even parity bit of the 2nd to 18th bits, while the 37th bit is the odd parity bit of the 19th to 36th bits. The 2nd to 4th bits is the manufacturer codes. The 5th to 14th bits is the device codes, and 15th to 20th bits are the site codes, and the 21st to 36th bits are the card numbers.</p>
<p>Wiegand50</p>	<p>ESSSSSSSSSSSSSSSSSSSSCCCCCCCCCCCCCCCCCCCCCCCCCCO</p> <p>It consists of 50 bits of binary code. The 1st bit is the even parity bit of the 2nd to 25th bits, while the 50th bit is the odd parity bit of the 26th to 49th bits. The 2nd to 17th bits is the site codes, and the 18th to 49th bits are the card numbers.</p>

"C" denotes the card number; "E" denotes the even parity bit; "O" denotes the odd parity bit; "F" denotes the facility code; "M" denotes the manufacturer code; "P" denotes the parity bit; and "S" denotes the site code.

6.6.2 Wiegand Output

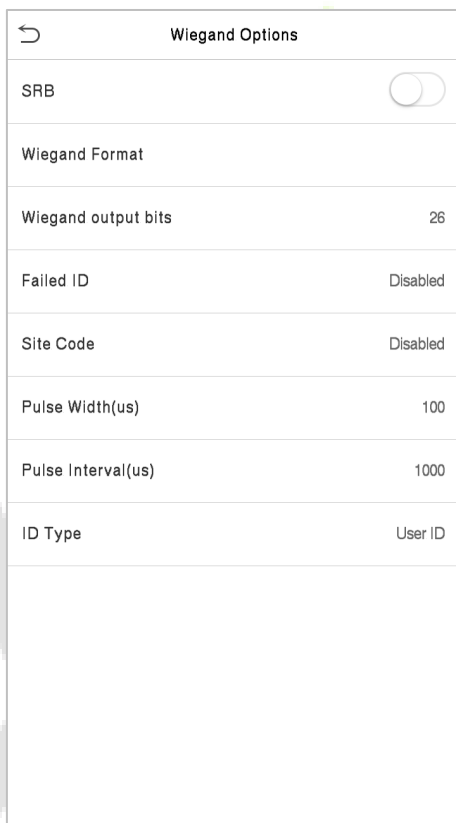

Function Description

Function Name	Descriptions
SRB	When SRB is enabled, the lock is controlled by the SRB to prevent the lock from opening due to device removal.
Wiegand Format	Its value can be 26 bits, 34 bits, 36 bits, 37 bits, and 50 bits.
Wiegand Output Bits	After selecting the required Wiegand format, select the corresponding output bit digits of the Wiegand format.
Failed ID	If the verification fails, the system will send the failed ID to the device and replace the card number or personnel ID with the new one.

Site Code	It is similar to the device ID. The difference is that a site code can be set manually and is repeatable on a different device. The valid value ranges from 0 to 256 by default.
Pulse Width(us)	The time width represents the changes in the quantity of electric charge with regular high-frequency capacitance within a specified time.
Pulse Interval(us)	The time interval between pulses.
ID Type	Select the ID types as either User ID or card number.

6.7 Network Diagnosis

To set the network diagnosis parameters.

Click **Network Diagnosis** on the Comm. Settings interface. Enter the IP address that needs to be diagnosed, and click **Start the diagnostic test** to check whether the network can connect to the device.

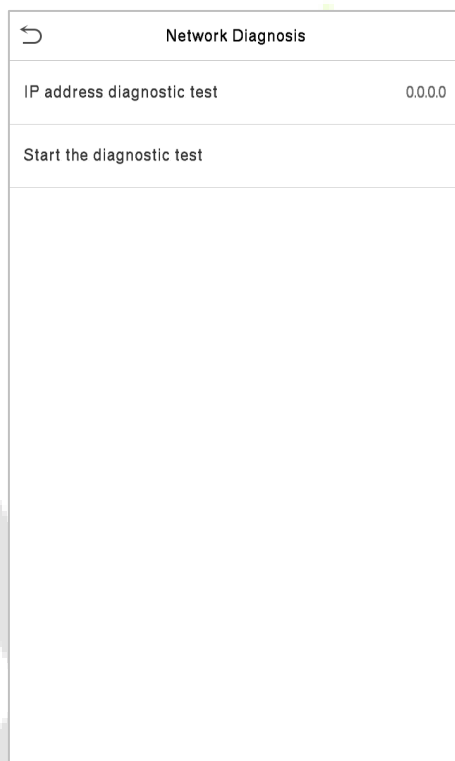

The screenshot shows a mobile application interface for 'Network Diagnosis'. At the top left is a back arrow icon. The title 'Network Diagnosis' is centered at the top. Below the title, there is a label 'IP address diagnostic test' followed by an input field containing the text '0.0.0.0'. At the bottom of the interface is a button labeled 'Start the diagnostic test'.

7 System Settings

It helps to set related system parameters to optimize the accessibility of the device.

Tap **System** on the **Main Menu** interface to get into its menu options.

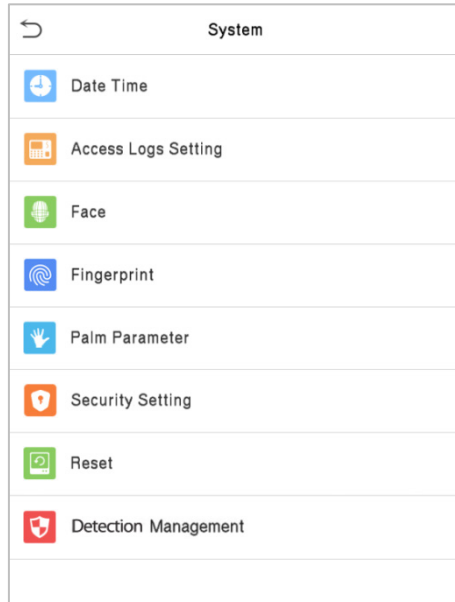

7.1 Date and Time

Tap **Date Time** on the **System** interface to set the date and time.

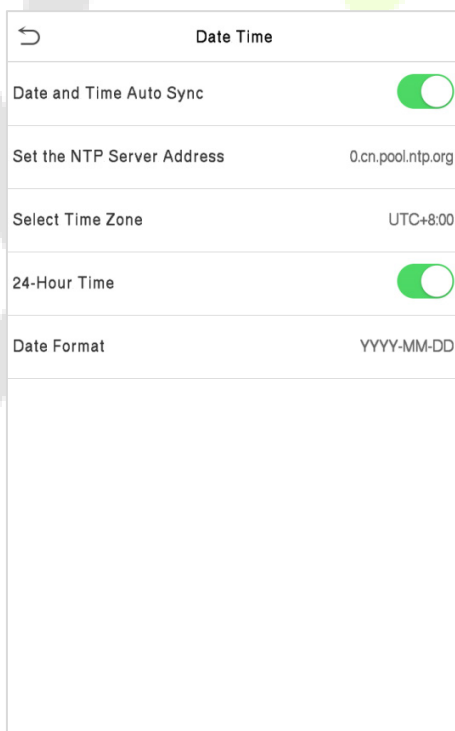

The product supports the NTP synchronization time system by default. This function takes effect after **Date and Time Auto Sync** is enabled and the corresponding NTP server address link is set.

If users need to set date and time manually, disable **Date and Time Auto Sync** first, and then tap **Manual Time Setting** to set date and time and tap Confirm to save.

Date Time	
Date and Time Auto Sync	<input type="checkbox"/>
Manual Date and Time	
Select Time Zone	UTC+8:00
24-Hour Time	<input checked="" type="checkbox"/>
Date Format	YYYY-MM-DD

Tap **Select Time Zone** to select a time zone then tap the return button to save and exit.

Tap **24-Hour Time** to enable or disable this format. If enabled, then select the **Date Format** to set the date format i.e., the way date should be displayed on the device.

★ Tap **Daylight Saving Time** to enable or disable the function. If enabled, tap **Daylight Saving Mode** to select a daylight-saving mode and then tap **Daylight Saving Setup** to set the switch time.

Daylight Saving Setup	
Start Month	1
Start Week	1
Start Day	Sunday
Start Time	00:00
End Month	1
End Week	1
End Day	Sunday
End Time	00:00

Week Mode

Daylight Saving Setup	
Start Date	00-00
Start Time	00:00
End Date	00-00
End Time	00:00

Date Mode

When restoring the factory settings, the time (24-hour) and date format (YYYY-MM-DD) can be restored, but the device date and time cannot be restored.

Note: For example, if a user sets the time of the device (18:35 on March 15, 2019) to 18:30 on January 1, 2020. After restoring the factory settings, the time of the device will remain at 18:30 on January 1, 2020.

7.2 Access Logs Setting

Click **Access Logs Setting** on the System interface.

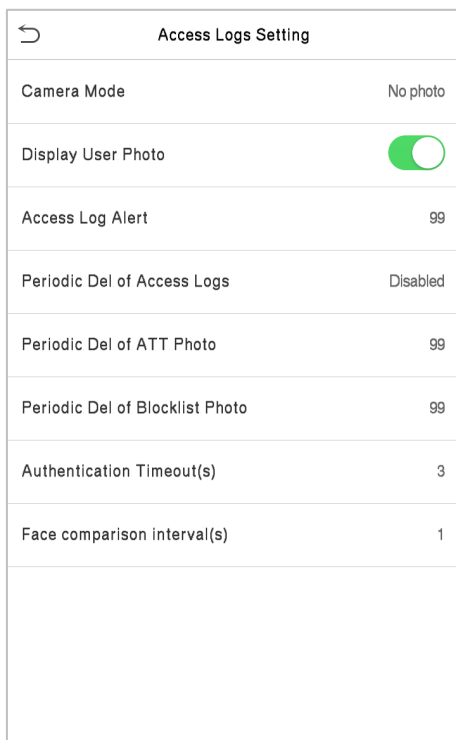

Function Description

Function Name	Description
Camera Mode	<p>This function is disabled by default. When enabled, a security prompt will pop-up and the sound of shutter in the camera will turn on mandatorily. There are 5 modes:</p> <p>No Photo: No photo is taken during user verification.</p> <p>Take photo, no save: Photo is taken but not saved during verification.</p> <p>Take photo and save: All the photos taken during verification is saved.</p> <p>Save on successful verification: Photo is taken and saved for each successful verification.</p> <p>Save on failed verification: Photo is taken and saved only for each failed verification.</p>
Display User Photo	<p>This function is disabled by default. When enabled, a security prompt will pop-up.</p>
Access Log Alert	<p>When the record space of the attendance access reaches the maximum threshold value, the device automatically displays the memory space warning. Users may disable the function or set a valid value between 1 and 9999.</p>
Periodic Del of Access Logs	<p>When access logs reach its maximum capacity, the device automatically deletes a set of old access logs. Users may disable the function or set a valid value between 1 and 999.</p>

Periodic Del of ATT Photo	When attendance photos reach its maximum capacity, the device automatically deletes a set of old attendance photos. Users may disable the function or set a valid value between 1 and 99.
Periodic Del of Blocklist Photo	When block listed photos reach its maximum capacity, the device automatically deletes a set of old block listed photos. Users may disable the function or set a valid value between 1 and 99.
Authentication Timeout (s)	The amount of time taken to display a successful verification message. Valid value: 1~9 seconds.
Face Comparison Interval (s)	The amount of time required to compare facial templates. Valid value: 0~9 seconds.

7.3 Face Parameters

Tap **Face** on the **System** interface to go to the face parameter settings.

Function Name	Value	Function Name	Value
1:N Threshold Value	74	Face Rotation Angle	25
1:1 Threshold Value	63	Image Quality	40
Face Enrollment Threshold	70	Minimum Face Size	80
Face Pitch Angle	35	LED Light Trigger Value	80
Face Rotation Angle	25	Motion Detection Sensitivity	4
Image Quality	40	Live Detection	<input type="checkbox"/>
Minimum Face Size	80	Live Detection Threshold	50
LED Light Trigger Value	80	Anti-spoofing using NIR	<input checked="" type="checkbox"/>
Motion Detection Sensitivity	4	WDR	<input type="checkbox"/>
Live Detection	<input type="checkbox"/>	Anti-flicker Mode	50HZ
Live Detection Threshold	50	Face Algorithm	
Anti-spoofing using NIR	<input checked="" type="checkbox"/>	Save Photo as Template	<input checked="" type="checkbox"/>

Function Description

Function Name	Description
1:N Match Threshold	Under 1:N verification mode, the verification will only be successful when the similarity between the acquired facial image and all registered facial templates is greater than the set value. The valid value ranges from 65 to 120. The higher the thresholds, the lower the misjudgement rate and the higher the rejection rate, and vice versa. It is recommended to set the default value of 75.

1:1 Match Threshold	<p>Under 1:1 verification mode, the verification will only be successful when the similarity between the acquired facial image and the user's facial templates enrolled in the device is greater than the set value.</p> <p>The valid value ranges from 55 to 120. The higher the thresholds, the lower the misjudgement rate and the higher the rejection rate, and vice versa. It is recommended to set the default value of 63.</p>
Face Enrollment Threshold	<p>During face enrollment, 1:N comparison is used to determine whether the user has already registered before.</p> <p>When the similarity between the acquired facial image and all registered facial templates is greater than the set threshold, it indicates that the face has already been registered.</p>
Face Pitch Angle	<p>It is the pitch angle tolerance of a face for facial template registration and comparison.</p> <p>If a face's pitch angle exceeds the set value, it will be filtered by the algorithm, i.e., ignored by the terminal thus no registration and comparison interface will be triggered.</p>
Face Rotation Angle	<p>It is the rotation angle tolerance of a face for facial template registration and comparison.</p> <p>If a face's rotation angle exceeds the set value, it will be filtered by the algorithm, i.e., ignored by the terminal thus no registration and comparison interface will be triggered.</p>
Image Quality	<p>It is the image quality for facial registration and comparison. The higher the value, the clearer image is required.</p>
Minimum Face Size	<p>It sets the minimum face size required for facial registration and comparison.</p> <p>If the minimum size of the captured image is smaller than the set value, then it will be filtered off and not recognized as a face.</p> <p>This value can also be interpreted as the face comparison distance. The farther the individual is, the smaller the face, and the smaller number of pixels of the face obtained by the algorithm. Therefore, adjusting this parameter can adjust the farthest comparison distance of faces. When the value is 0, the face comparison distance is not limited.</p>
LED Light Trigger Threshold	<p>This value controls the turning on and off of the LED light. The larger the value, the LED light will turn on or off more frequently.</p>
Motion Detection Sensitivity	<p>It sets the value for the amount of change in a camera's field of view known as potential motion detection that wakes up the terminal from standby to the comparison interface.</p> <p>The larger the value, the more sensitive the system would be, i.e., if a larger value is set, the comparison interface activates with much ease, and the motion detection is frequently triggered.</p>
Live Detection	<p>It detects the spoof attempt using visible light images to determine if the provided biometric source sample is of a real person (a live human being) or a false representation.</p>
Live Detection Threshold	<p>It facilitates judging whether the captured visible image is a real person (a live human being). The larger the value, the better the anti-spoofing performance using visible light.</p>

Anti-counterfeiting with NIR	Using near-infrared spectra imaging to identify and prevent fake photos and videos attack.
WDR	Wide Dynamic Range (WDR) balances light and extends image visibility for surveillance videos under high contrast lighting scenes and improves object identification under bright and dark environments.
Anti-flicker Mode	It is used when WDR is turned off. It helps to reduce flicker when the device's screen flashes at the same frequency as the light.
Face Algorithm	It has facial algorithm related information and pause facial template update.
Save Photo as Template	This function is enabled by default, and the menu interface supports enabling or disabling this function, and there is a security prompt when switching. When this function is disabled, it will indicate that there is a risk reminder: " Face re-registration is required after an algorithm upgrade. "

Note: Improper adjustment of the exposure and quality parameters may severely affect the performance of the device. Please adjust the exposure parameter only under the guidance of the after-sales service personnel of our company.

- **Process to modify the Face Recognition Accuracy**
- On the **System** interface, tap on **Face** and then toggle to enable Anti-Spoofing using NIR to set the anti-spoofing.
- Then, on the **Main Menu**, tap **Auto-Test > Test Face** and perform the face test.
- Tap three times for the scores on the right upper corner of the screen, and the red rectangular box appears to start adjusting the mode.
- Keep one arm distance between the device and the face. It is recommended not to move the face in a wide range.

7.4 Fingerprint Parameters

Click **Fingerprint** on the System interface.

Fingerprint	
1:1 Threshold Value	15
1:N Threshold Value	35
FP Sensor Sensitivity	Low
1:1 Retry Attempts	3
Fingerprint Image	Always show

FRR	FAR	Recommended matching thresholds	
		1:N	1:1
High	Low	45	25
Medium	Medium	35	15
Low	High	25	10

Function Description

Function Name	Descriptions
1:1 Match Threshold	Under 1:1 verification method, the verification will only be successful when the similarity between the acquired fingerprint data and the fingerprint template associated with the entered user ID enrolled in the device is greater than the set value.
1:N Match Threshold	Under 1:N verification method, the verification will only be successful when the similarity between the acquired fingerprint data and the fingerprint templates enrolled in the device is greater than the set value.
FP Sensor Sensitivity	To set the sensibility of fingerprint acquisition. It is recommended to use the default level " Medium ". When the environment is dry, resulting in slow fingerprint detection, you can set the level to " High " to raise the sensibility; when the environment is humid, making it hard to identify the fingerprint, you can set the level to " Low ".
1:1 Retry Times	In 1:1 Verification, users might forget the registered fingerprint, or press the finger improperly. To reduce the process of re-entering user ID, retry is allowed.
Fingerprint Image	<p>This function is disabled by default. After disabling it, the fingerprint image will not be displayed when registering and verifying fingerprints. The menu interface allows to enable or disable this function, and there are security prompts when switching. Four choices are available:</p> <p>Show for enroll: to display the fingerprint image on the screen only during enrollment.</p> <p>Show for match: to display the fingerprint image on the screen only during verification.</p> <p>Always show: to display the fingerprint image on screen during enrollment and verification.</p> <p>None: not to display the fingerprint image.</p>

7.5 Video Intercom Parameters

Click **Video intercom parameters** on the System interface.

←
Video intercom parameters

QR code binding

Intercom Server Setting

Calling Timeout(s) 20

Function Description

Function Name	Description
QR Code Binding	Use the ZSmart APP client to scan the QR code to connect and bind the device.
Intercom Server Setting	Set the IP address and port number of the intercom server. Server Address: Enter the sever installation IP address. Server Port: It is the service port set during installation (not the ADMS port).
Calling Timeout (s)	If the call is not answered within a specified time, it exits to the main interface.

7.6 Security Settings

Tap **Security Settings** on the **System** interface.

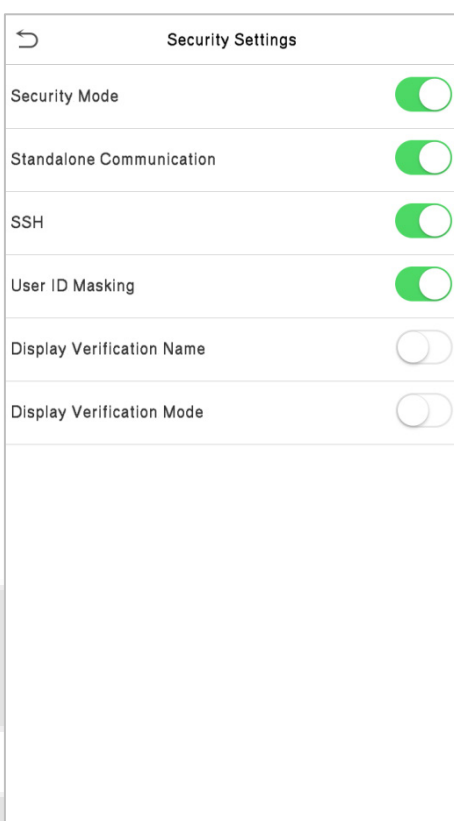

Function Description

Function Name	Description
Security Mode	When enabled, user information verification has a high level of security. This function can be enabled or disabled via the menu interface. When switching on and off, there are security prompts. All data will be deleted and the device will be restarted after confirmation. Note: After turning on the security mode, the product will forcibly enable the function of returning to the standby interface when the menu times out by default (default 60s). It does not support disabling in security mode, but it does support disabling in non-security mode. To configure, go to Personalize > User Interface > Menu Screen Timeout(s) .

Standalone Communication	By default, this function is disabled. This function can be enabled or disabled via the menu interface. When it is switched on, a security prompt appears, and the device will restart after you confirm.
SSH	The device does not support the Telnet feature, hence SSH is typically used for remote debugging. By default, SSH is enabled. The menu interface allows you to enable and disable SSH. When enabled, there will be a security prompt, but the device will not need to be restarted after confirmation.
User ID Masking	After enabled, the User ID will be partially displayed after the personnel verification result (only the User ID with more than 2 digits supports the masking display), and it is enabled by default.
Display Verification Name	After enabled, the user's name will be displayed after the personnel verification result. The verification result will not show the name after disabling it.
Display Verification Mode	After enabled, the personnel verification result will show the user's verification mode. The verification result will not show the verification mode after you disable it.

7.7 Factory Reset

The Factory Reset function restores the device settings such as communication settings and system settings, to the default factory settings (this function does not clear registered user data).

Tap **Reset** on the **System** interface and then tap **OK** to restore the default factory settings.

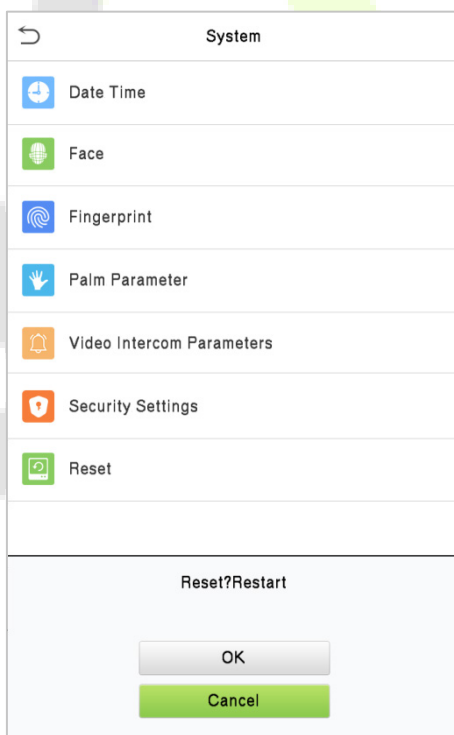

7.8 Detection Management★

Click **Detection Management** on the System interface.

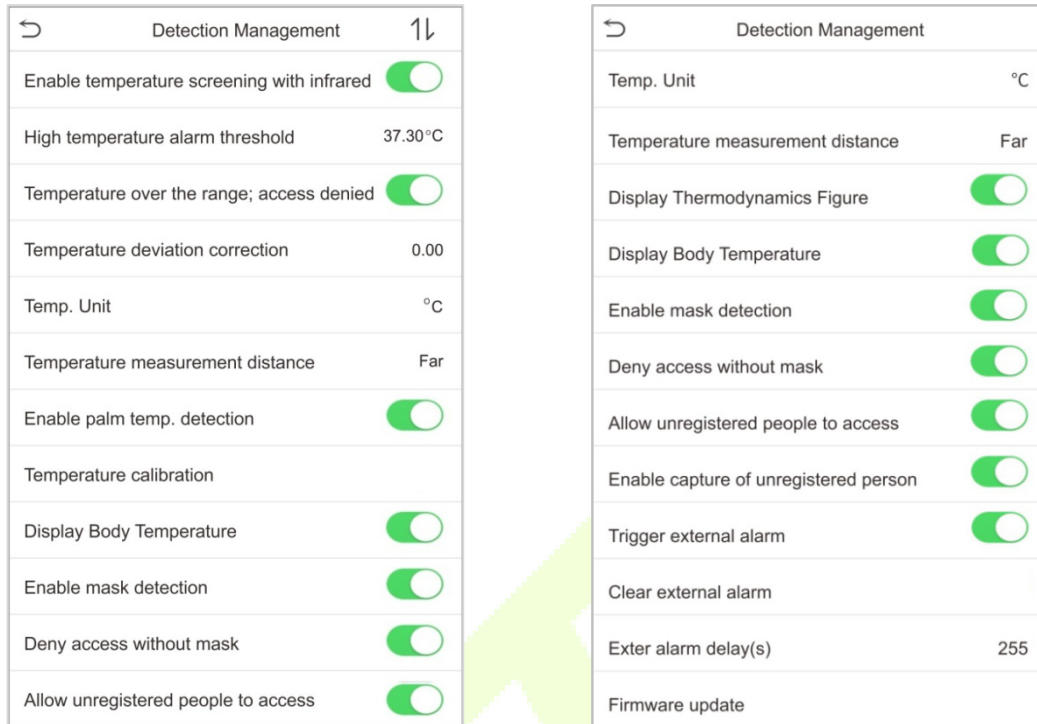

Function Name	Description
Enable Temperature Screening with Infrared	To enable or disable the infrared temperature measurement function. When this function is enabled, before the access is granted, users must pass the temperature screening in addition to identity verification. To measure body temperature, users' faces must be aligned with the temperature measurement area.
High Temperature Alarm Threshold	To set the value of the alarm threshold of high body temperature. When the temperature measured during verification is higher than the set value, the device will give a prompt and audio alarm. The default alarm threshold is 37.30°C.
Temperature Over the Range; Access Denied	When this function is enabled, if the user's body temperature measured is above (or below) the alarm threshold, the user will not be granted access even if his/her identity is verified. If this function is disabled, the user is allowed to access the restricted area when his/her identity is verified, regardless of his/her body temperature.
Temperature Deviation Correction	As the temperature measurement module allows a small range of errors (disturbance) of an observed value under different environments (humidity, room temperature and such), users may set the deviation value here.
Temp. Unit	The unit of body temperature can be switched between Celsius (°C) and Fahrenheit (°F).

Temperature Measurement Distance	When measuring temperature during the verification process, there are three modes: Near, Close and Far.
Display Thermodynamics Figure★	To enable or disable the display of the thermal image of a person. When enabled, the thermal image of the person is displayed in the upper left corner of the device during the detection process.
Enable Palm Temp. Detection★	To enable or disable the palm temperature detection function. When enabled, the device will display the user's palm temperature during the verification process. Note: This function is not enabled by default, and can be upgraded to support.
Temperature Calibration★	Calibrate the temperature by comparing the current temperature value with the surface temperature value of the device.
Enable Mask Detection	To enable or disable the mask detection function. When it's enabled, the device will identify whether the user is wearing a mask or not during verification.
Display Body Temperature	To enable or disable the display body temperature function. When enabled, the device will display the user's specific temperature value during the verification process.
Enable Mask Detection	To enable or disable the mask detection function. When it's enabled, the device will identify whether the user is wearing a mask or not during verification.
Deny Access without Mask	To enable or disable the deny access without mask function. When it's enabled, even if the body temperature is normal, the person who does not wear a mask will not allow the person to enter.
Allow Unregistered People to Access	To enable or disable the unregistered people to access function. When enabled, as long as the person who passes the detection, the device allows the personnel to enter without registration.
Enable Capture of Unregistered Person	To enable or disable the capture of unregistered person function. When enabled, the device will automatically capture the photo of the unregistered person, enabling this feature requires to enable Allow Unregistered People to Access .
Trigger External Alarm★	When enabled, if the user's temperature is higher than the set threshold value or the mask detection is enabled, but the mask is not worn by the person, it will trigger an alarm.
Clear External Alarm★	It clears the triggered alarm records of the device.
External Alarm Delay(s)★	The delay (s) time for triggering an external alarm. It can be set in seconds. Users may disable the function or set a value between 1 to 255.

Firmware Update★

Choose whether to update the thermal imaging temperature detection module software version.



8 Personalize Settings

Tap **Personalize** on the **Main Menu** interface to customize interface settings, voice, bell, punch state options, and shortcut key mappings.

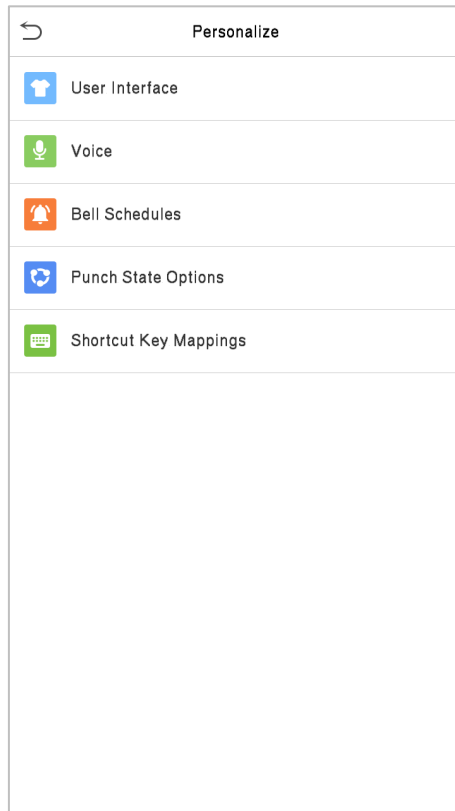

8.1 Interface Settings

Tap **User Interface** on the **Personalize** interface to customize the display style of the main interface.

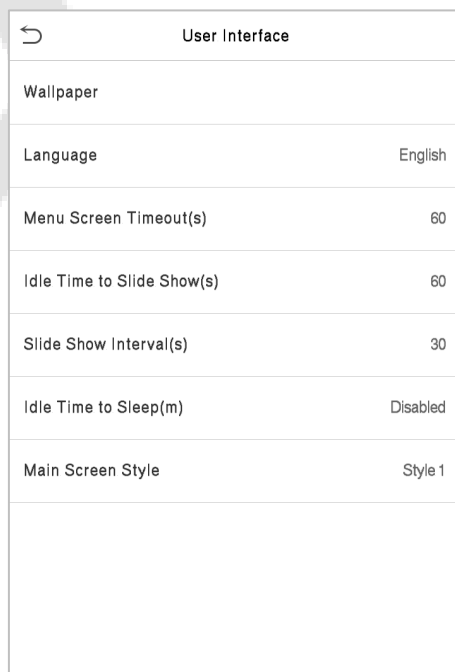

Function Description

Function Name	Description
Wallpaper	It helps to select the main screen wallpaper according to the user preference.
Language	It helps to select the language of the device.
Menu Screen Timeout (s)	When there is no operation, and the time exceeds the set value, the device automatically goes back to the initial interface. The function can either be disabled or set the required value between 60 and 99999 seconds.
Idle Time To Slide Show (s)	When there is no operation, and the time exceeds the set value, a slide show is displayed. The function can be disabled, or you may set the value between 3 and 999 seconds.
Slide Show Interval (s)	It is the time interval in switching between different slide show pictures. The function can be disabled, or you may set the interval between 3 and 999 seconds.
Idle Time To Sleep (m)	If the sleep mode is activated, and when there is no operation in the device, then the device will enter standby mode. This function can be disabled or set a value within 1-999 minutes.
Main Screen Style	The style of the main screen can be selected according to the user preference.

8.2 Voice Settings

Tap **Voice** on the **Personalize** interface to configure the voice settings.

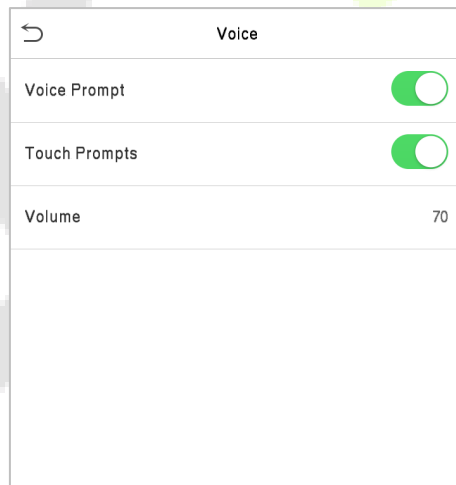

Function Description

Function Name	Description
Voice Prompt	Select whether to enable voice prompts during operating.
Touch Prompt	Select whether to enable keypad sounds.
Volume	Adjust the volume of the device; valid value: 0-100.

8.3 Bell Schedules

Tap **Bell Schedules** on the **Personalize** interface to configure the Bell settings.

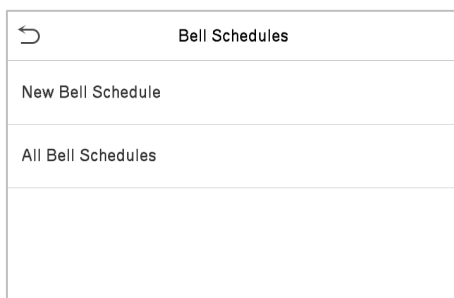

- **New Bell Schedule**

Tap **New Bell Schedule** on the **Bell Schedule** interface to add a new bell schedule.

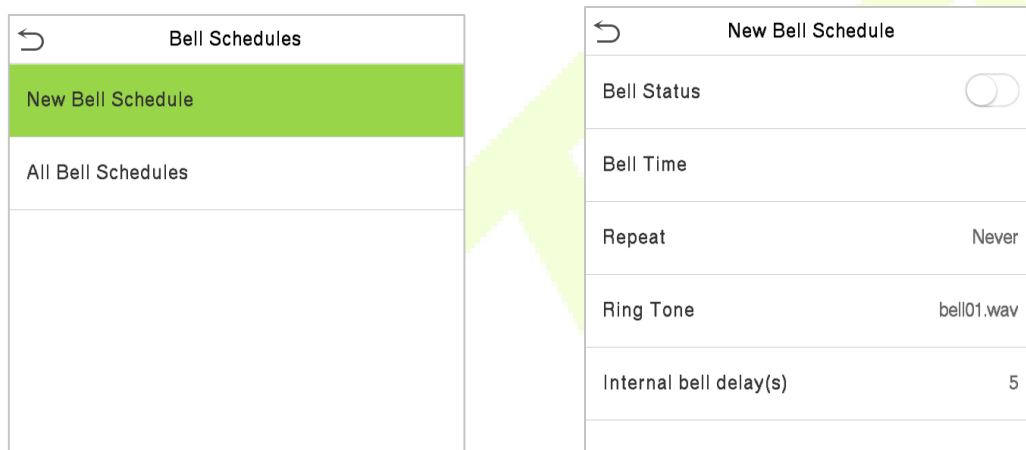

Function Description

Function Name	Description
Bell Status	Toggle to enable or disable the bell status.
Bell Time	Once the required time is set, the device automatically triggers to ring the bell during that time.
Repeat	Set the required number of counts to repeat the scheduled bell.
Ring Tone	Select a ringtone.
Internal Bell Delay(s)	Set the replay time of the internal bell. Valid values range from 1 to 999 seconds.

- **All Bell Schedules**

Once the bell is scheduled, on the **Bell Schedules** interface, tap **All Bell Schedules** to view the newly scheduled bell.

- **Edit the Scheduled Bell**

On the **All Bell Schedules** interface, tap on the required bell schedule, and tap **Edit** to edit the selected bell schedule. The editing method is the same as the operations of adding a new bell schedule.

● Delete a Bell

On the **All Bell Schedules** interface, tap the required bell schedule, and tap **Delete**, and then tap **Yes** to delete the selected bell.

8.4 Punch States Options

Tap **Punch States Options** on the **Personalize** interface to configure the punch state settings.

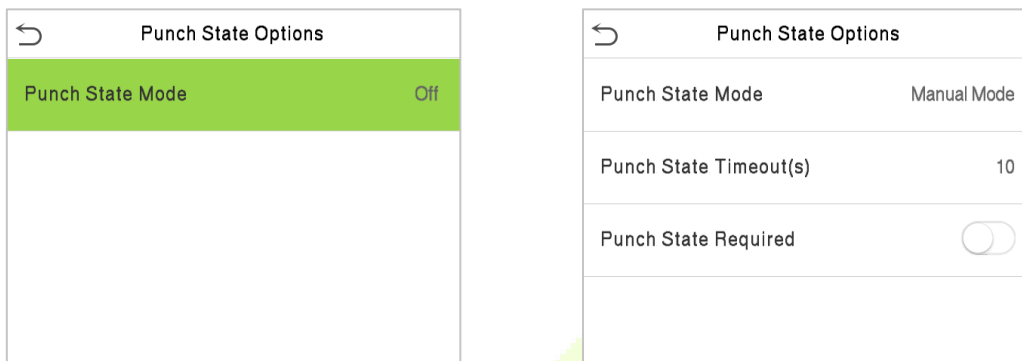

Function Description

Function Name	Description
Punch State Mode	<p>Select a punch state mode, which can be:</p> <p>Off: It disables the punch state function. And the punch state key set under the Shortcut Key Mappings menu becomes invalid.</p> <p>Manual Mode: Switch the punch state key manually, and the punch state key will disappear after Punch State Timeout.</p> <p>Auto Mode: The punch state key will automatically switch to a specific punch status according to the predefined schedule which can be set in the Shortcut Key Mappings.</p> <p>Manual and Auto Mode: The main interface will display the auto-switch punch state key. However, the users will still be able to select an alternative that is the manual attendance status. After the timeout, the manual switching punch state key will become an auto-switch punch state key.</p> <p>Manual Fixed Mode: After the punch state key is set manually to a particular punch status, the function will remain unchanged until manually switched again.</p> <p>Fixed Mode: Only the manually fixed punch state key is shown. Users cannot change the status by pressing any other keys.</p>
Punch State Timeout (s)	It is the amount of time for which the punch state is displayed. The value ranges from 5~999 seconds.
Punch State Required	To choose whether an attendance state needs to be selected during verification.

8.5 Shortcut Keys Mappings

Users may define shortcut keys for attendance status and functional keys on the main interface. So, on the main interface, when the shortcut keys are pressed, the corresponding attendance status or the function interface displays directly.

Tap **Shortcut Key Mappings** on the **Personalize** interface to set the required shortcut keys.

Shortcut Key Mappings	
F1	Check-In
F2	Check-Out
F3	Break-Out
F4	Break-In
F5	Overtime-In
F6	Overtime-Out

- On the **Shortcut Key Mappings** interface, tap on the required shortcut key to configure the shortcut key settings.
- On the **Shortcut Key** ("F1") interface, tap **function** to set the functional process of the shortcut key either as punch state key or function key.
- If the Shortcut key is defined as a function key (such as New user, All users, etc.), the configuration is done as shown in the image below.

F1	
Punch State Value	0
Function	Punch State Options
Name	Check-In

F1	
Function	New User

- If the Shortcut key is set as a punch state key (such as check-in, check-out, etc.), then it is required to set the punch state value (valid value 0~250), name, and switch time.

9 Data Management

On the **Main Menu**, tap **Data Mgt.** to delete the relevant data in the device.



9.1 Delete Data

Tap **Delete Data** on the **Data Mgt.** interface to delete the required data.

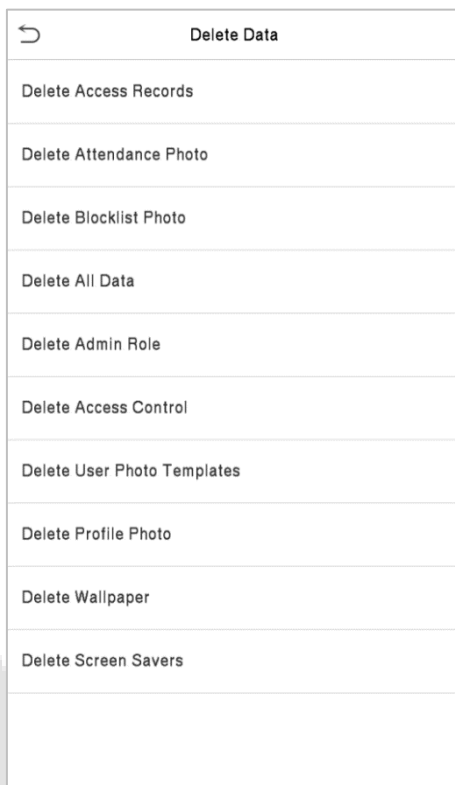

Function Description

Function Name	Description
Delete Access Records	To delete attendance data/access records conditionally.
Delete Attendance Photo	To delete attendance photos of designated personnel.
Delete Blocklist Photo	To delete the photos taken during failed verifications.
Delete All Data	To delete information and attendance logs/access records of all registered users.
Delete Admin Role	To remove all administrator privileges.
Delete Access Control	To delete all access data.
Delete User Photo Templates	To delete user photo templates in the device. When deleting template photos, there is a risk reminder: "Face re-registration is required after an algorithm upgrade."

Delete Profile Photo	To delete all user photos in the device.
Delete Wallpaper	To delete all wallpapers in the device.
Delete Screen Savers	To delete the screen savers in the device.

The user may select **Delete All** or **Delete by Time Range** when deleting the access records, attendance photos or block listed photos. Selecting **Delete by Time Range**, you need to set a specific time range to delete all data within a specific period.

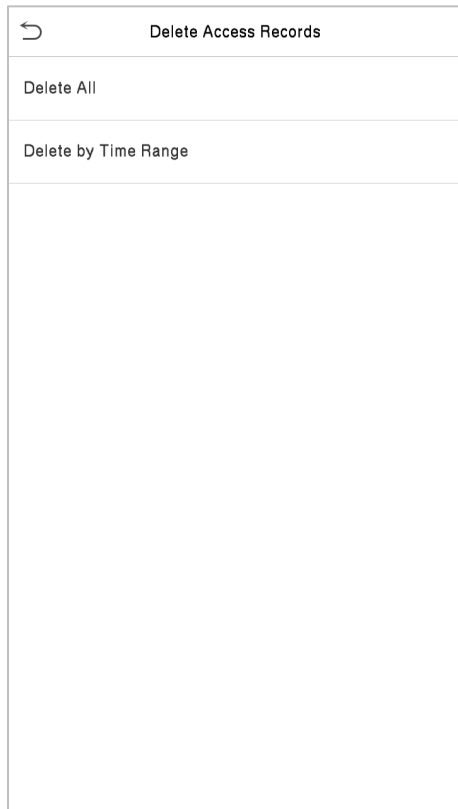

Select Delete by Time Range

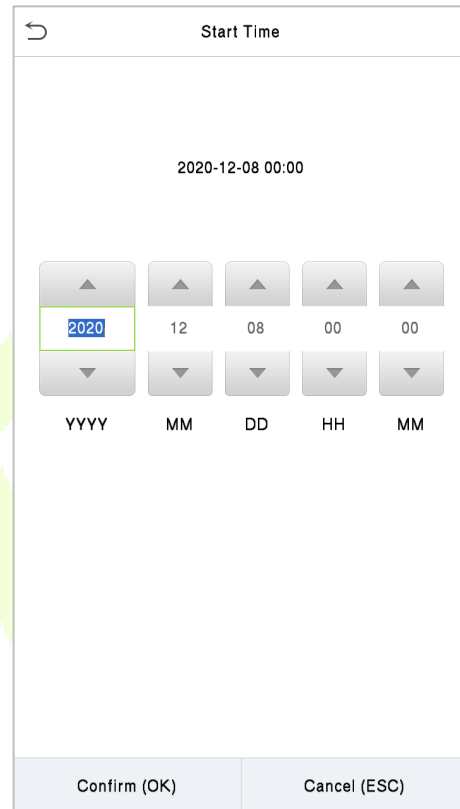

Set the time range and click **OK**

10 Access Control

On the **Main Menu**, tap **Access Control** to set the schedule of the door opening, locks control and to configure other parameters settings related to access control.

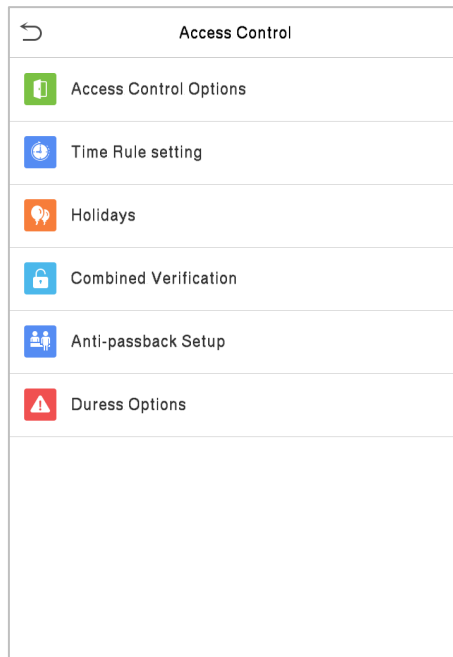

To gain access, the registered user must meet the following conditions:

- The relevant door's current unlock time should be within any valid time zone of the user's time period.
- The corresponding user's group must be already set in the door unlock combination (and if there are other groups, being set in the same access combo, then the verification of those group's members is also required to unlock the door).
- In default settings, new users are allocated into the first group with the default group time zone, where the access combo is "1" and is set in unlock state by default.

10.1 Access Control Options

Tap **Access Control Options** on the **Access Control** interface to set the parameters of the control lock of the terminal and related equipment.

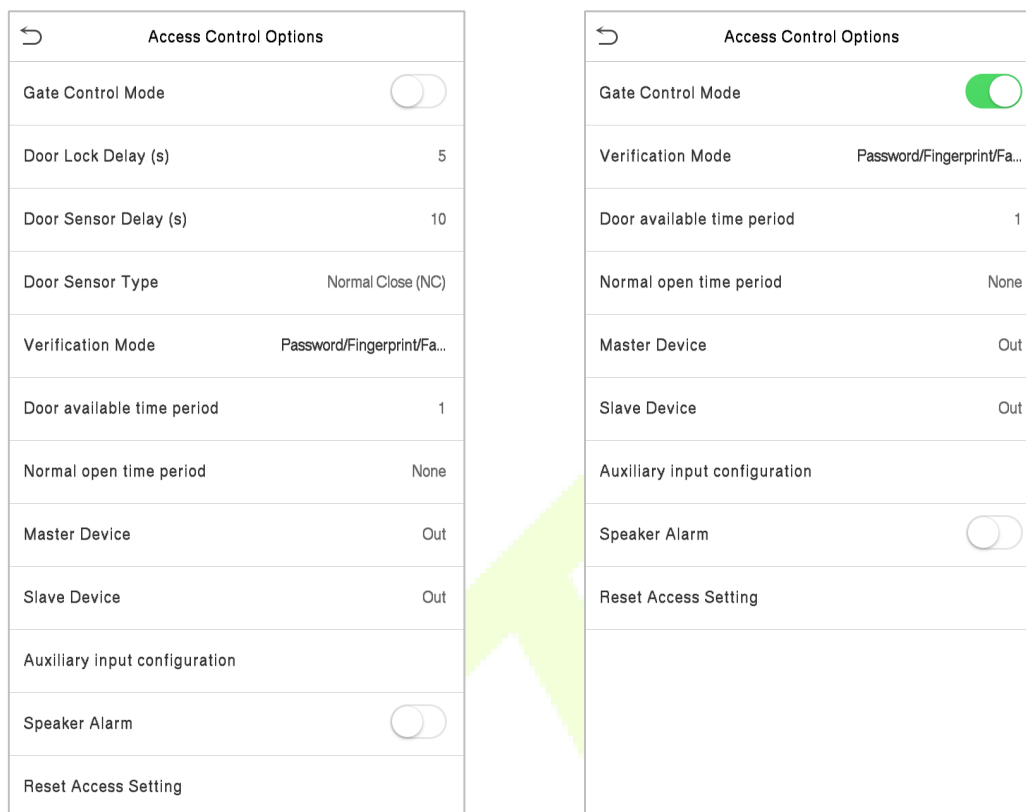

Function Description

Function Name	Description
Gate Control Mode	It toggles between ON or OFF switch to get into gate control mode or not. When set to ON , the interface removes the Door lock relay, Door sensor relay, and Door sensor type options.
Door Lock Delay (s)	The length of time that the device controls the electric lock to be in unlock state. Valid value: 1~10 seconds; 0 seconds represents disabling the function.
Door Sensor Delay (s)	If the door is not locked and is left open for a certain duration (Door Sensor Delay), an alarm will be triggered. The valid value of Door Sensor Delay ranges from 1 to 255 seconds.
Door Sensor Type	There are three Sensor types: None , Normal Open , and Normal Closed . None: It means the door sensor is not in use. Normally Open: It means the door is always left open when electric power is on. Normally Closed: It means the door is always left closed when electric power is on.

Verification Mode	The supported verification mode includes Password/Fingerprint/Face, Fingerprint only, User ID only, Password, User ID + Fingerprint, Fingerprint + Password, User ID + Fingerprint + Password, Face only, Face + Fingerprint, Face + Password, Face + Fingerprint + Password.
Door Available Time Period	It sets the timing for the door so that the door is accessible only during that period.
Normal Open Time Period	It is the scheduled time-period for "Normal Open" mode so that the door is always open during this period.
Master Device	While configuring the master and slave devices, you may set the state of the master as Out or In . Out: A record of verification on the master device is a check-out record. In: A record of verification on the master device is a check-in record.
Slave Device	While configuring the master and slave devices, you may set the state of the slave as Out or In . Out: A record of verification on the slave device is a check-out record. In: A record of verification on the slave device is a check-in record.
Auxiliary Input Configuration	Sets the door unlock time period and auxiliary output type of the auxiliary terminal device. Auxiliary output types include None, Trigger door open, Trigger Alarm, Trigger door open and Alarm.
Speaker Alarm	It transmits a sound alarm or disassembly alarm from the local. When the door is closed or the verification is successful, the system cancels the alarm from the local.
Reset Access Setting	The access control reset parameters include door lock delay, door sensor delay, door sensor type, verification mode, door available time period, normal open time period, master device, and alarm. However, erased access control data in Data Mgt. is excluded.

10.2 Time Schedule

Tap **Time Rule Setting** on the Access Control interface to configure the time settings.

- The entire system can define up to 50 Time Periods.
- Each time-period represents **10** Time Zones, i.e., **1** week and **3** holidays, and each time zone is a standard 24 hour period per day and the user can only verify within the valid time-period.
- One can set a maximum of 3 time periods for every time zone. The relationship among these time-periods is "**OR**". Thus, when the verification time falls in any one of these time-periods, the verification is valid.
- The Time Zone format of each time-period is **HH MM-HH MM**, which is accurate to minutes according to the 24-hour clock.

Tap the grey box to search the required Time Zone and specify the required Time Zone number (maximum up to 50 zones).

Time Rule[2/50]	
Sunday	[00:00 23:59] [00:00 23:59]
Monday	[00:00 23:59] [00:00 23:59]
Tuesday	[00:00 23:59] [00:00 23:59]
Wednesday	[00:00 23:59] [00:00 23:59]
Thursday	[00:00 23:59] [00:00 23:59]
Friday	[00:00 23:59] [00:00 23:59]
Saturday	[00:00 23:59] [00:00 23:59]
holiday type 1	[00:00 23:59] [00:00 23:59]
holiday type 2	[00:00 23:59] [00:00 23:59]
holiday type 3	[00:00 23:59] [00:00 23:59]

On the selected Time Zone number interface, tap on the required day (that is Monday, Tuesday, etc.) to set the time.

Time Period 1

00:00 23:59

▲	▲	▲	▲
00	00	23	59
▼	▼	▼	▼
HH	MM	HH	MM

Confirm (OK) Cancel (ESC)

Specify the start and the end time, and then tap **OK**.

Note:

- The door is inaccessible for the whole day when the End Time occurs before the Start Time (such as **23:57~23:56**).
- It is the time interval for valid access when the End Time occurs after the Start Time (such as **08:00~23:59**).
- The door is accessible for the whole day when the End Time occurs after the Start Time (such that Start Time is **00:00** and End Time is **23:59**).
- The default Time Zone 1 indicates that the door is open all day long.

10.3 Holidays

Whenever there is a holiday, you may need a distinct access time; but changing everyone's access time one by one is extremely cumbersome, so a holiday access time can be set that applies to all employees and the user will be able to open the door during the holidays.

Tap **Holidays** on the **Access Control** interface to set the Holiday access.

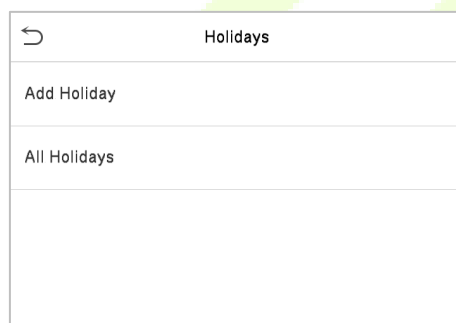

- **Add a New Holiday**

Tap **Add Holiday** on the **Holidays** interface and set the holiday parameters.

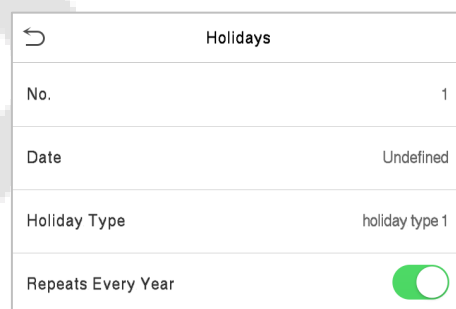

- **Edit a Holiday**

On the **Holidays** interface, select a holiday item to be modified. Tap **Edit** to modify holiday parameters.

- **Delete a Holiday**

On the **Holidays** interface, select a holiday item to be deleted and tap **Delete**. Press **OK** to confirm the deletion. After deletion, this holiday does not display on the **All Holidays** interface.

10.4 Combined Verification

Access groups are arranged into different door-unlocking combinations to achieve multiple verifications and strengthen security.

In a door-unlocking combination, the range of the combined number N is $0 \leq N \leq 5$ and the number of members N may all belong to one access group or may belong to five different access groups.

Tap **Combined Verification** on the **Access Control** interface to configure the combined verification setting.

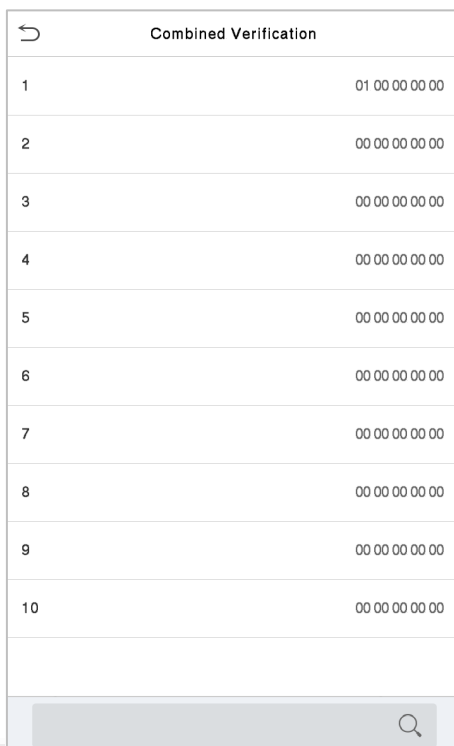

Combined Verification	
1	01 00 00 00 00
2	00 00 00 00 00
3	00 00 00 00 00
4	00 00 00 00 00
5	00 00 00 00 00
6	00 00 00 00 00
7	00 00 00 00 00
8	00 00 00 00 00
9	00 00 00 00 00
10	00 00 00 00 00

On the combined verification interface, tap the Door-unlock combination to be set, and tap the **up** and **down** arrows to input the combination number, and then press **OK**.

For Example:

- If the **Door-unlock combination 1** is set as **(01 03 05 06 08)**. It indicates that the unlock combination 1 consists of 5 people and all the 5 individuals are from 5 groups, namely, AC Group 1, AC Group 3, AC Group 5, AC Group 6, and AC Group 8, respectively.
- If the **Door-unlock combination 2** is set as **(02 02 04 04 07)**. It indicates that the unlock combination 2 consists of 5 people; the first two are from AC Group 2, the next two are from AC Group 4, and the last person is from AC Group 7.
- If the **Door-unlock combination 3** is set as **(09 09 09 09 09)**. It indicates that there are 5 people in this combination; all of which are from AC Group 9.
- If the **Door-unlock combination 4** is set as **(03 05 08 00 00)**. It indicates that the unlock combination 4 consists of only three people. The first person is from AC Group 3, the second person is from AC Group 5, and the third person is from AC Group 8.

Note: To delete the door-unlock combination, set all Door-unlock combinations to 0.

10.5 Anti-passback Setup

A user may be followed by some person(s) to enter the door without verification, resulting in a security breach. So, to avoid such situations, the Anti-Passback option was developed. Once it is enabled, the check-in and check-out record must occur alternatively to open the door to represent a consistent pattern.

This function requires two devices to work together:

One device is installed on the indoor side of the door (master device), and the other one is installed on the outdoor side of the door (the slave device). The two devices communicate via the Wiegand signal. The Wiegand format and Output type (User ID / Card Number) adopted by the master device and slave device must be consistent.

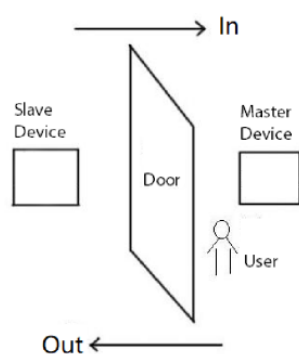

Tap **Anti-Passback Setup** on the **Access Control** interface.

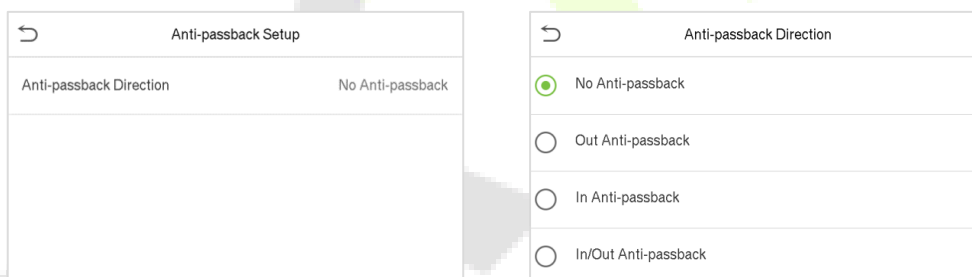

Function Description

Function Name	Description
Anti-passback Direction	<p>No Anti-Passback: The Anti-Passback function is disabled, which means successful verification through either the master device or slave device can unlock the door. The attendance state is not saved in this option.</p> <p>Out Anti-Passback: The user can check-out only if the last record is a check-in record otherwise an alarm is raised. However, the user can check-in freely.</p> <p>In Anti-Passback: The user can check-in again only if the last record is a check-out record otherwise an alarm is raised. However, the user can check-out freely.</p> <p>In/Out Anti-Passback: In this case, a user can check-in only if the last record is a check-out or the user can check-out only if the last record is a check-in otherwise the alarm is triggered.</p>

10.6 Duress Options Settings

Once a user activates the duress verification function with a specific authentication method(s), and when he/she is under coercion and authenticates using duress verification, the device unlocks the door as usual. At the same time, a signal is sent to trigger the alarm as well.

On the **Access Control** interface, tap **Duress Options** to configure the duress settings.

Duress Options	
Alarm on Password	<input type="checkbox"/>
Alarm on 1:1 Match	<input type="checkbox"/>
Alarm on 1: N Match	<input type="checkbox"/>
Alarm Delay(s)	10
Duress Password	None

Function Description

Function Name	Description
Alarm on Password	When a user uses the password verification method, an alarm signal will be generated, otherwise there will be no alarm signal.
Alarm on 1:1 Match	When a user uses the 1:1 verification method, an alarm signal will be generated, otherwise there will be no alarm signal.
Alarm on 1:N Match	When a user uses the 1:N verification method, an alarm signal will be generated, otherwise there will be no alarm signal.
Alarm Delay (s)	Alarm signal will not be transmitted until the alarm delay time is elapsed. The value ranges from 1 to 999 seconds.
Duress Password	Set the 6-digit duress password. When the user enters this duress password for verification, an alarm signal will be generated.

11 Attendance Search

Once the identity of a user is verified, the access record is saved in the device. This function enables users to check their event logs.

Select **Attendance Search** on the **Main Menu** interface to search for the required event Logs.

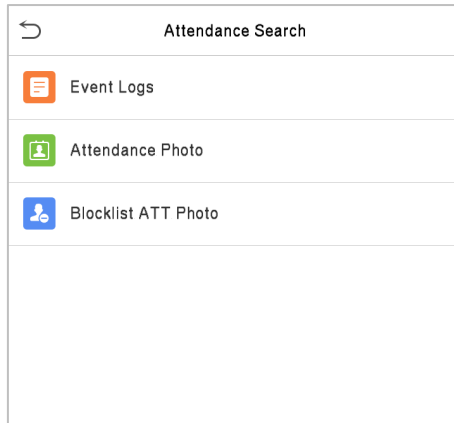

The process of searching for attendance and blocklist photos is similar to that of searching for event logs. The following is an example of searching for event logs.

On the **Attendance Search** interface, tap **Event Logs** to search for the required record.

1. Enter the user ID to be searched and tap **OK**. If you want to search for records of all users, tap **OK** without entering any user ID.
2. Select the time range in which the records need to be searched.

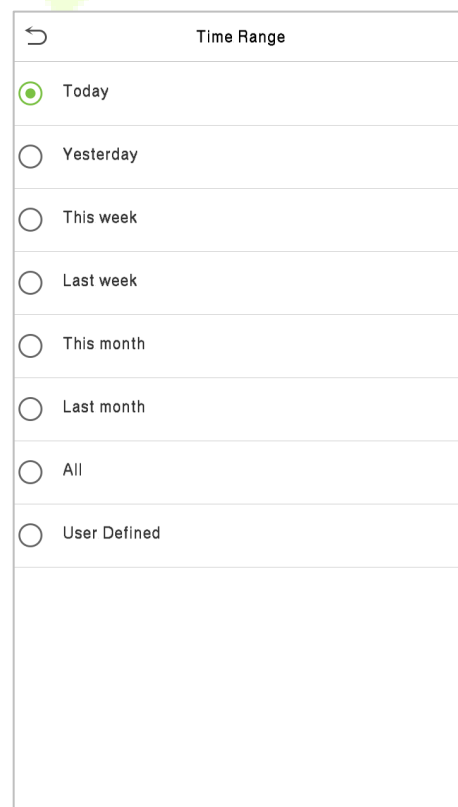
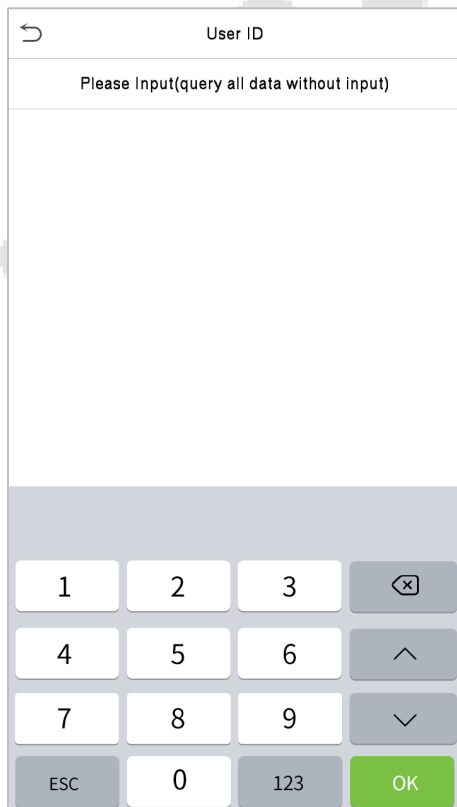

3. Once the record search completes. Tap the record highlighted in green to view its details.

Personal Record Search		
Date	User ID	Time
12-08		Number of Records:05
	0	08:16 08:16 06:19 06:18 06:18
12-07		Number of Records:48
	0	15:05 15:05 13:41 13:41 13:31
		13:30 13:29 13:28 13:27 13:27
		13:27 13:27 13:26 13:26 13:26
		13:25 12:26 12:26 10:54 10:54
		10:50 10:50 10:50 10:49 10:28
		10:28 10:28 10:27 10:26 10:26
		09:09 09:09
	1	15:00 14:59 14:55 14:55 14:55
		14:24 14:24 14:24 14:24 14:24
		14:24 14:24 14:23 14:23 12:21
		12:21

4. The below figure shows the details of the selected record.

Personal Record Search				
User ID	Name	Time	Mode	State
0		12-08 08:16	200	2
0		12-08 08:16	200	2
0		12-08 06:19	1	1
0		12-08 06:18	200	2
0		12-08 06:18	200	2

Verification Mode : Other Status : 2

12 Autotest

Select **Main Menu**, tap **Autotest**. It enables the system to automatically test whether the functions of various modules are working normally, including the LCD, Voice, Camera, and Real-Time Clock (RTC).

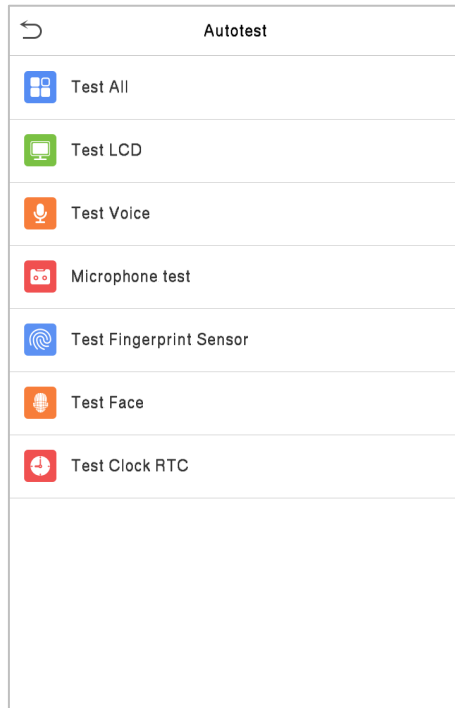

Function Description

Function Name	Description
Test All	To automatically test whether the LCD, audio, camera and RTC are normal.
Test LCD	To automatically test the display effect of LCD screen by displaying full-color, pure white, and pure black to check whether the screen displays colors normally.
Test Voice	To automatically test whether the audio files stored in the device are complete and the voice quality is good.
Microphone Test	To test if the microphone is working properly by speaking into the microphone.
Test Fingerprint Sensor	To test the fingerprint sensor by pressing a finger on the scanner to check if the acquired fingerprint image is clear. When you are pressing a finger on the scanner, the fingerprint image will display on the screen.
Test Face	To test if the camera functions properly by checking the pictures taken to see if they are clear enough.
Test Clock RTC	To test the RTC. The device tests whether the clock works normally and accurately with a stopwatch. Touch the screen to start counting and press it again to stop counting.

13 System Information

On the **Main Menu**, tap **System Info** to view the storage status, the version information of the device, and firmware information.

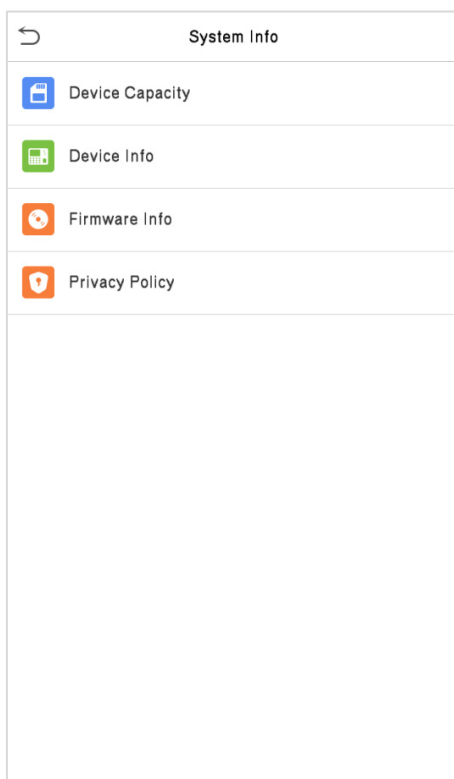

Function Description

Function Name	Description
Device Capacity	Displays the current device's user storage, password, and face storage, administrators, access records, attendance and blocklist photos, and user photos.
Device Info	Displays the device's name, serial number, MAC address, face algorithm, platform information, and manufacturer and manufacture date.
Firmware Info	Displays the firmware version and other version information of the device.
Privacy Policy	<p>The privacy policy control will appear when the gadget turns on for the first time. After clicking "I have read it," the customer can use the product regularly. Click System Info -> Privacy Policy to view the content of the privacy policy. The privacy policy's content does not allow for U disc export.</p> <p>Note: The current privacy policy's text is only available in Simplified Chinese/English. However, translation of other multi-language content is underway, with more iterations.</p>

14 LAN Video Intercom Function Settings★

14.1 Installing ZKBio VMS Plugin in the ZKBioSecurity Software

● Install the ZKBioSecurity Software

While installing, select the "VMS" module of the ZKBioSecurity software to install, as shown in the following installation interface.

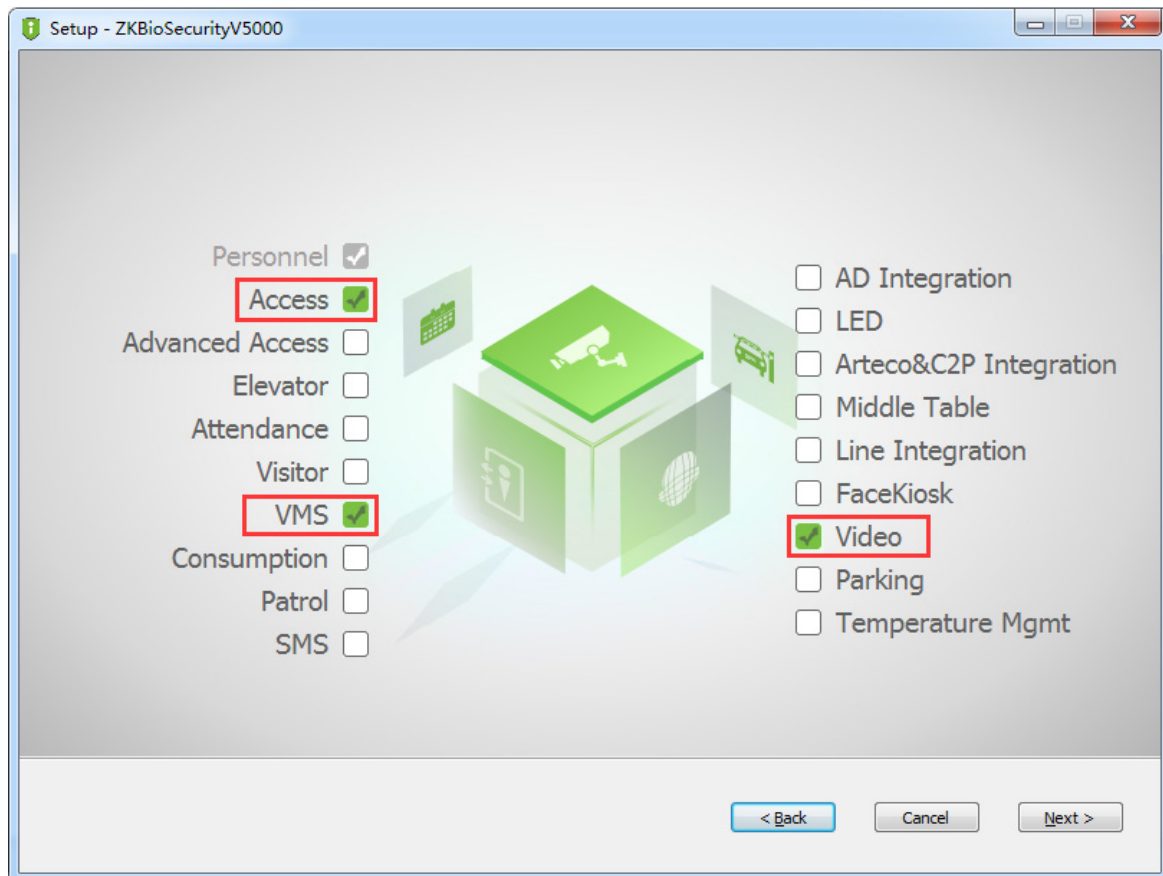

Note: The Video module and the VMS module cannot be selected at the same time.

● Installing the ZKBio VMS Plugin

Double-click on the provided **ZKBioVMSPlugin_sqlite.exe** file to install the ZKBio VMS Plugin.

Note: The ZKBioSecurity software and ZKBio VMS Plugin need to be opened simultaneously to recognize the intercom function.

14.2 Configuration Parameters

Set the required parameters correctly to ensure a connection between the device and the software.

1. Add site on the Video-VMS plugin

- Double click the  icon to open the Video-VMS Plugin. Click ***Choose site > Site management > Add** on the login interface. Then, enter the Name, IP address, and Port to add a site, as shown in the following figure.

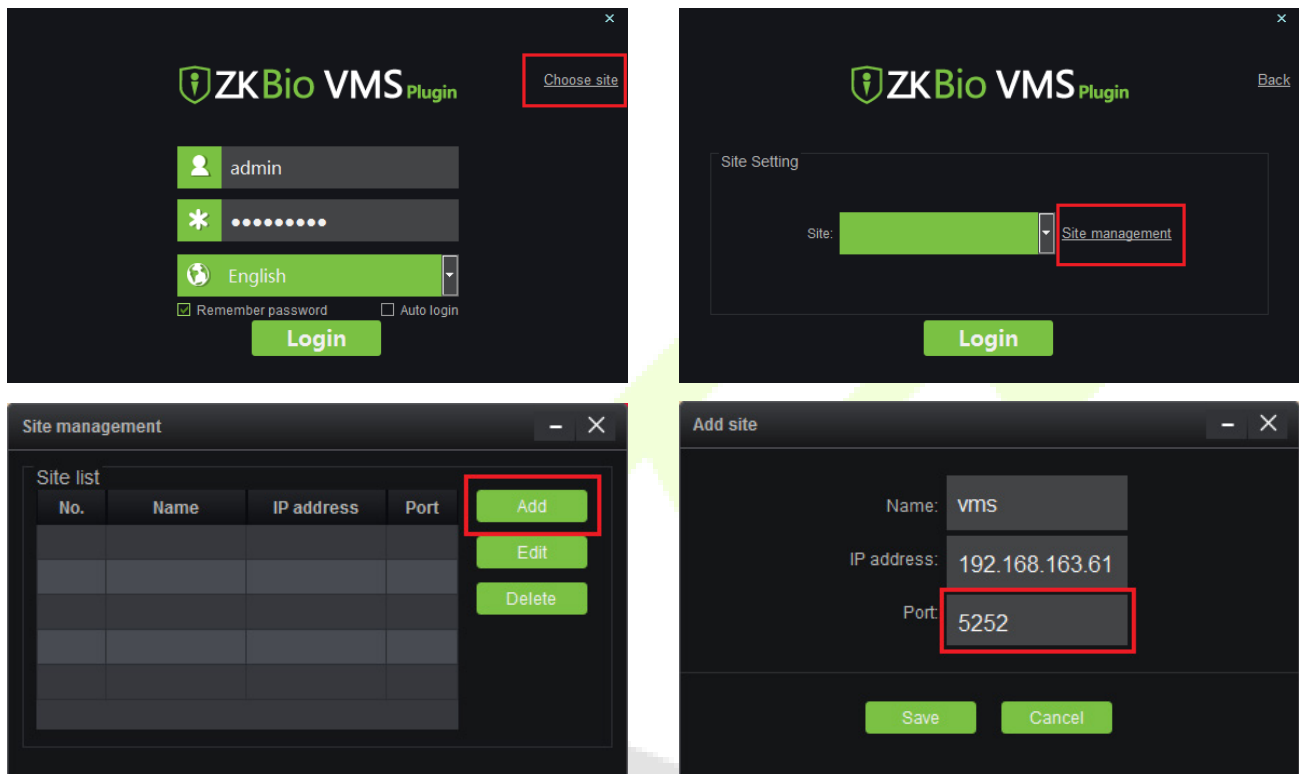

IP address: Enter the local IP address.

Port: The default port is **5252**.

- Enter the username and the password after adding the site and click **Login** to login the Video-VMS plugin. The username and the initial password are both **admin**.

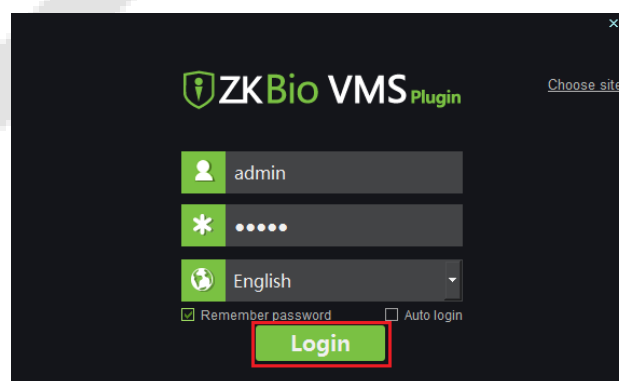

Note: When the Video-VMS plugin is connected successfully to the ZKBioSecurity, the password changes synchronously to the admin user password of the ZKBioSecurity.

2. Configure the connection path of the ZKBioSecurity and VMS plugin

Click **Video > Connection > Connection Management** on the ZKBioSecurity software to change the path, as shown in the following image:

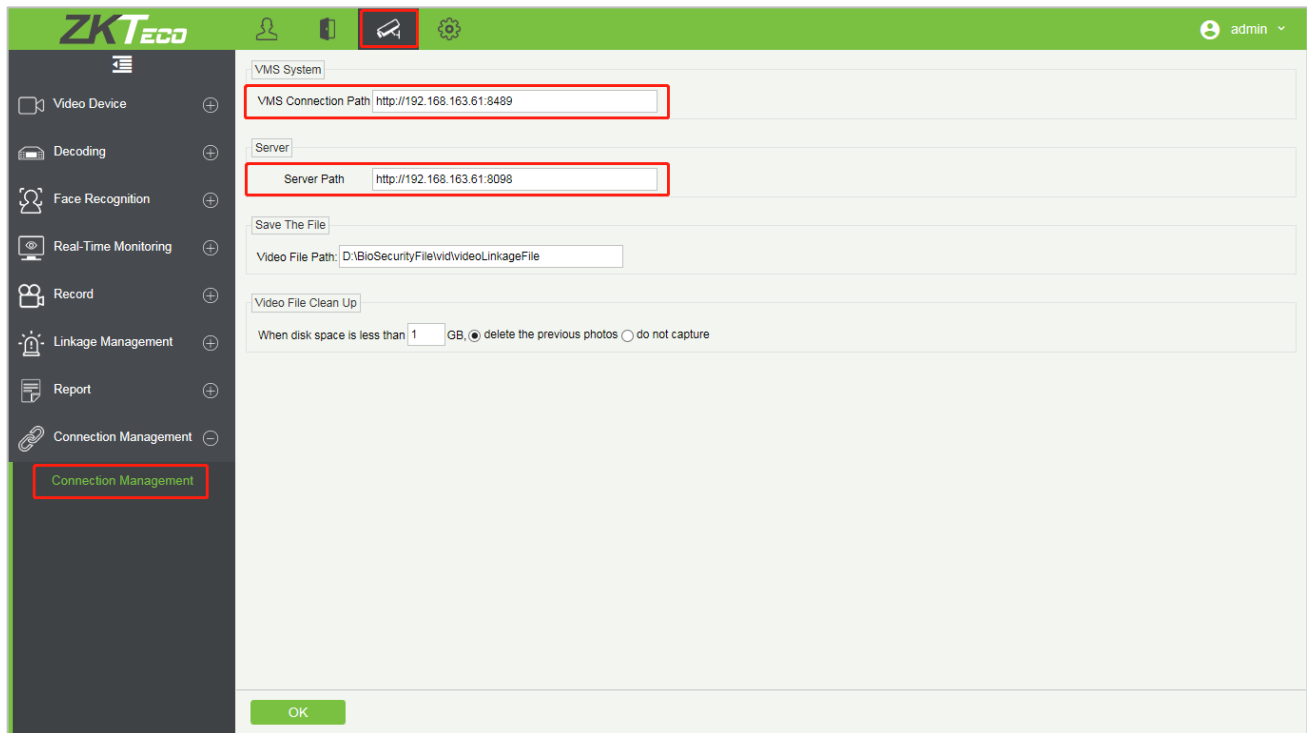



VMS Connection Path

- **URL:** "<http://local IP address: port>"
- **Port:** It is **8489** by default (e.g., <http://192.168.163.61:8489>).

Server Path

- **URL:** "<http://server IP address: port>"
- **Port:** The port is the service port set during installation (e.g., <http://192.168.163.61:8098>) (not the ADMS port).

3. Configure the parameters on the device

- Click on  > **COMM.** > **Cloud Server Setting** on device to set the server address and server port, i.e., the IP address and port number of the server after the software is installed. If the device communicates with the server successfully, the icon  is displayed in the upper right corner of the standby interface.
- Click on  > **System** > **Video Intercom Parameters** > **Intercom Server Setting** to set the server address and server port.

Server Address: Enter the ZKBioSecurity installation IP address.

Server Port: The port is the service port set during installation (not the ADMS port).

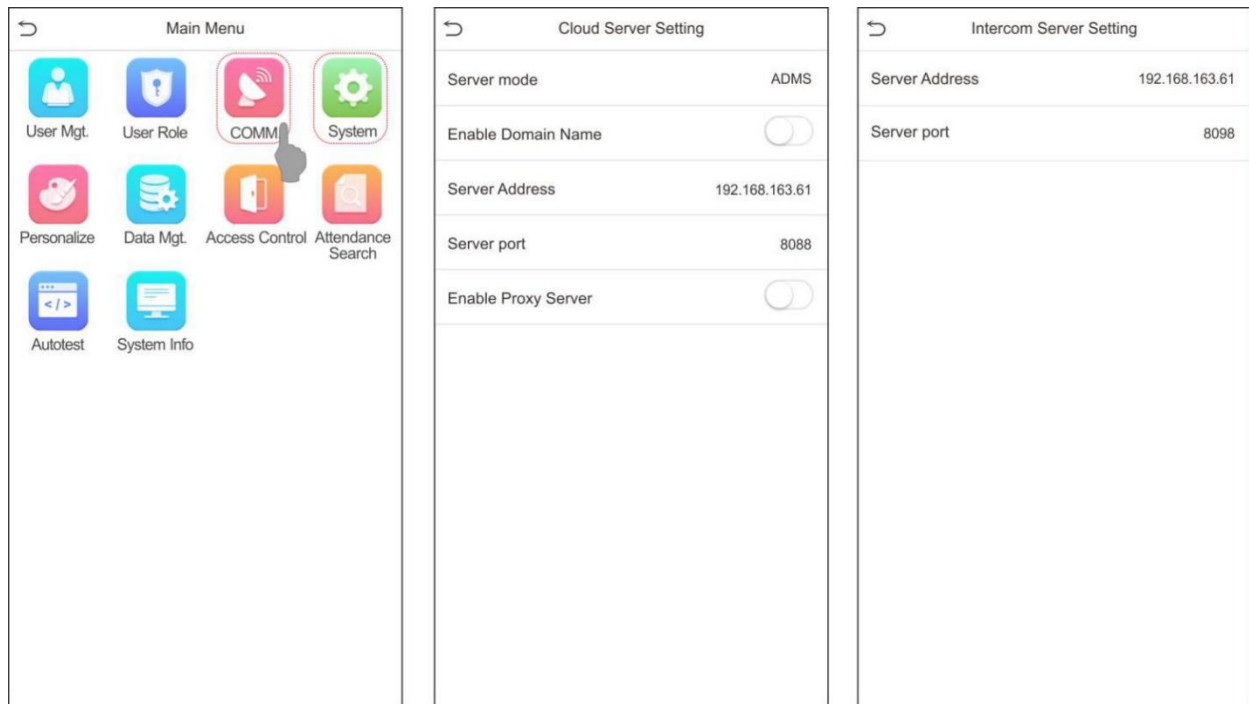

4. Adding device on the ZKBioSecurity software

- a. Click **Access > Device > Device > Search** to add the device on the ZKBioSecurity software.

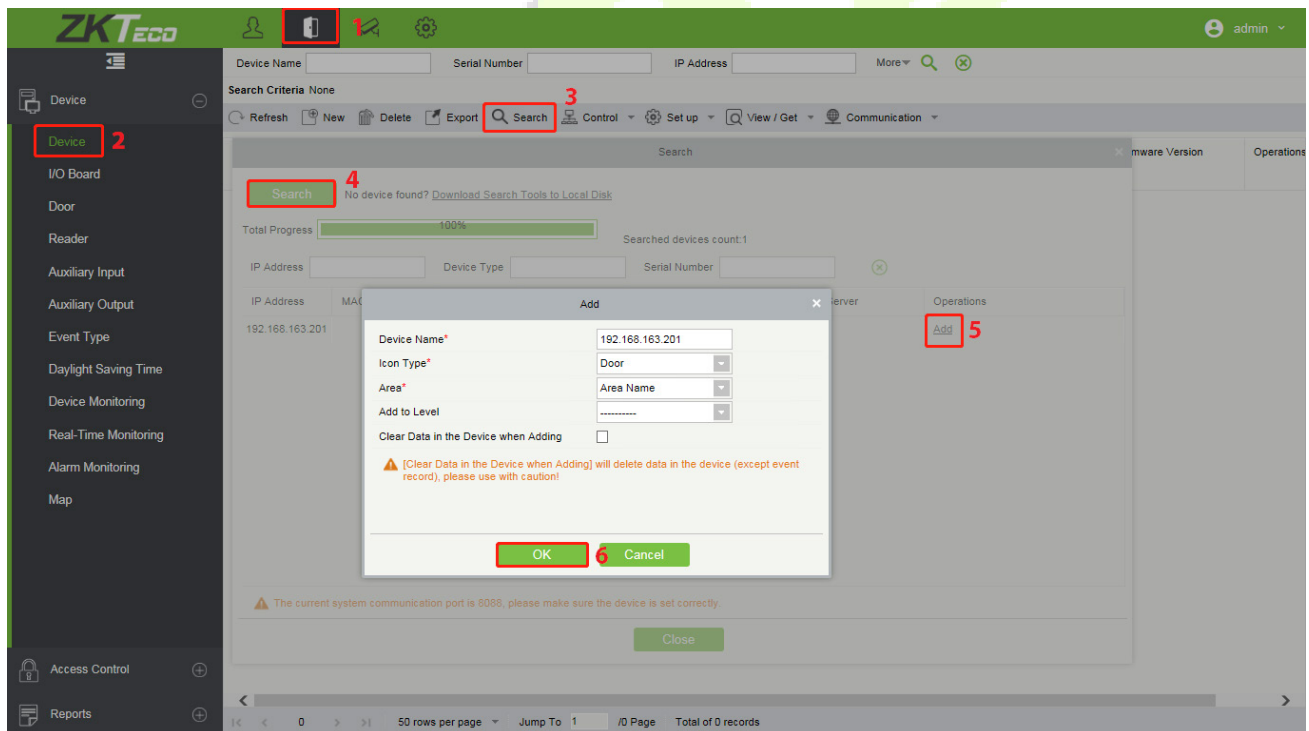

- b. After the device is added successfully to the access module, it automatically adds to the video module. User can click **Video > Video Device > Search** to view.

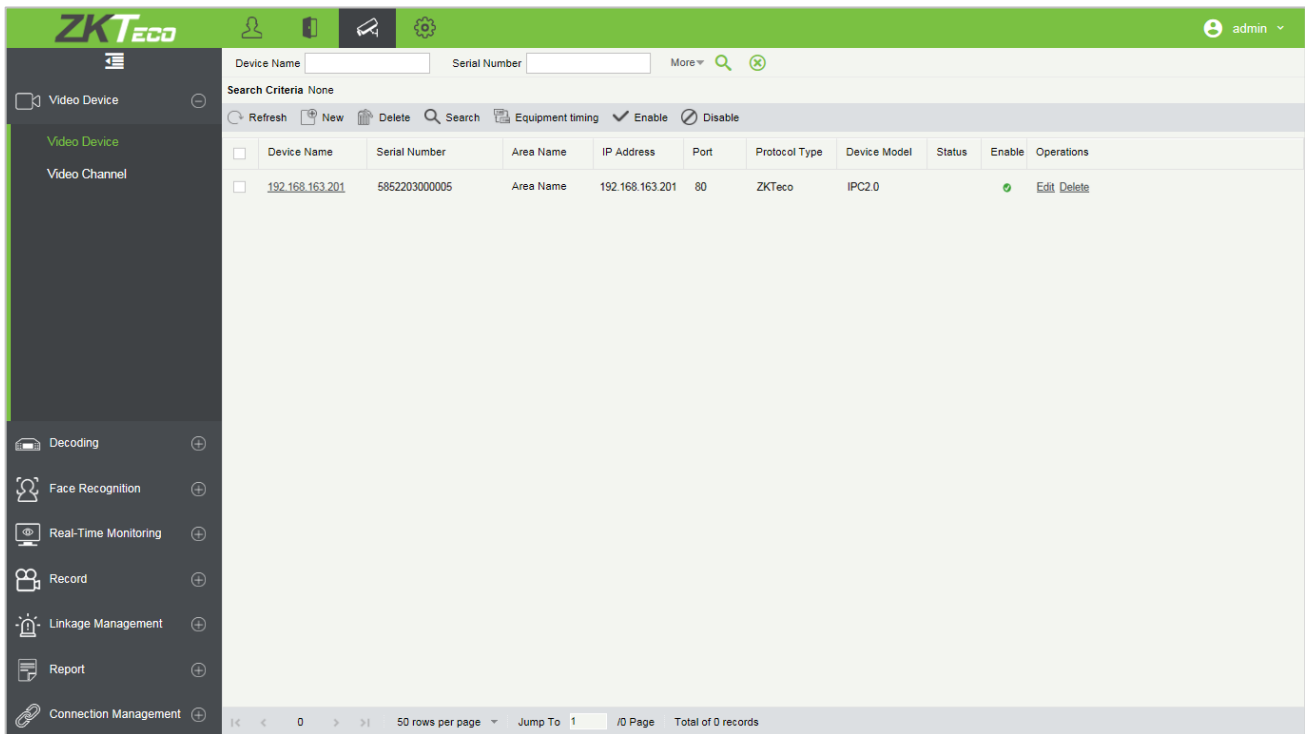

Note: If the device is not added to the Video module, please check whether the parameter settings are correct.

14.3 Video Preview on the ZKBioSecurity Software

Click **Video > Real-Time Monitoring > Video Preview** to enter the preview interface of the device.

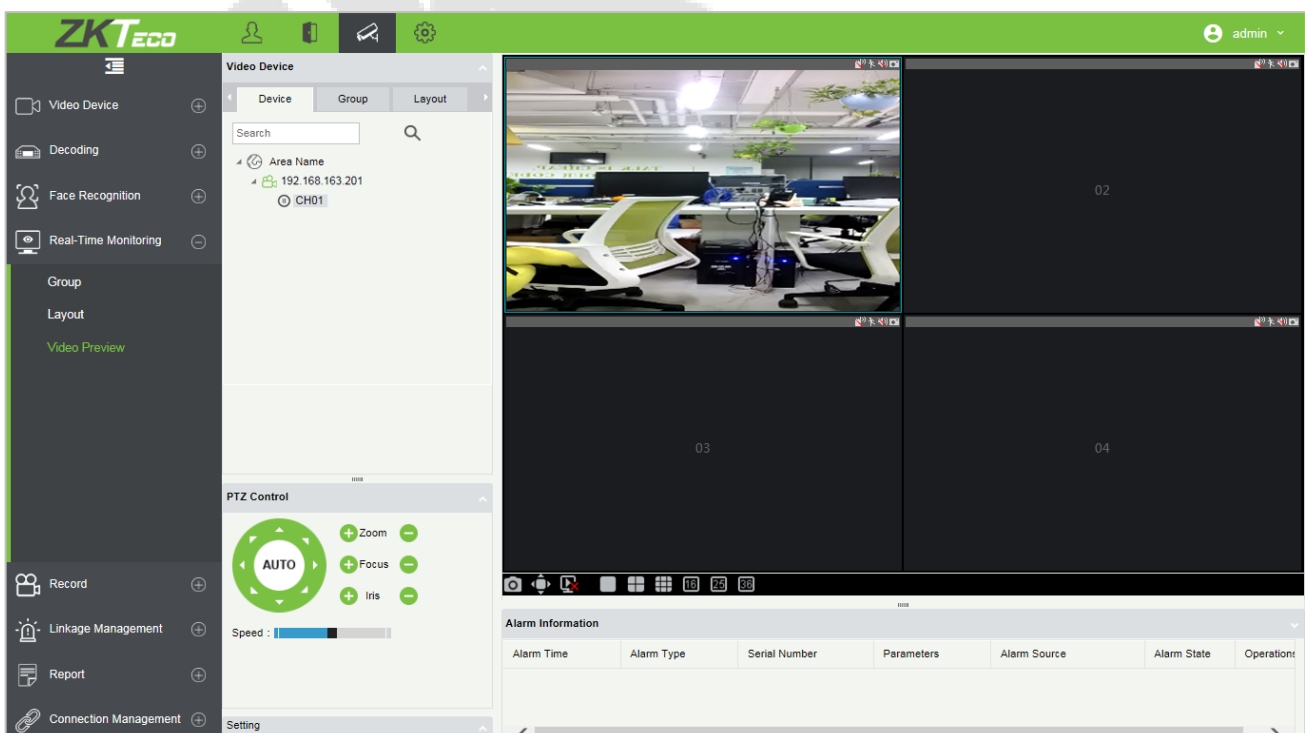

14.4 Make a Call on the Device

1. Click on  icon on the welcome screen of the device to make a call.

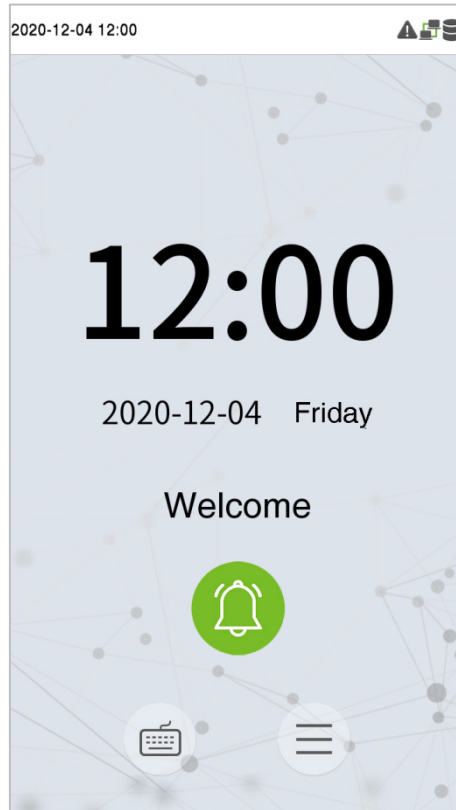

2. The server page pops up the call window by default, as shown in the following figure.

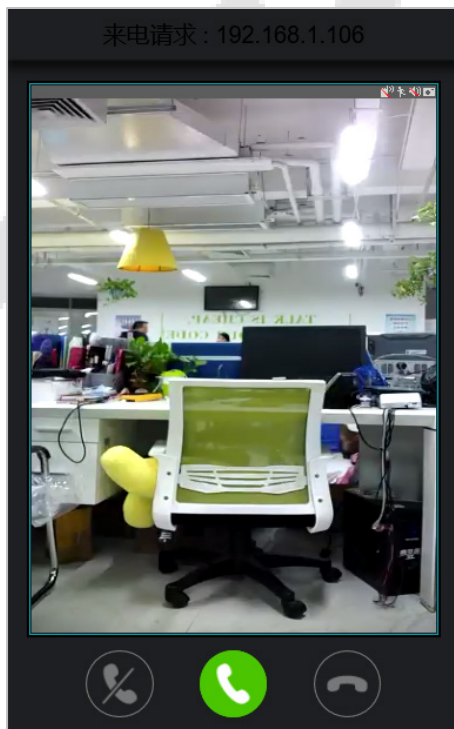



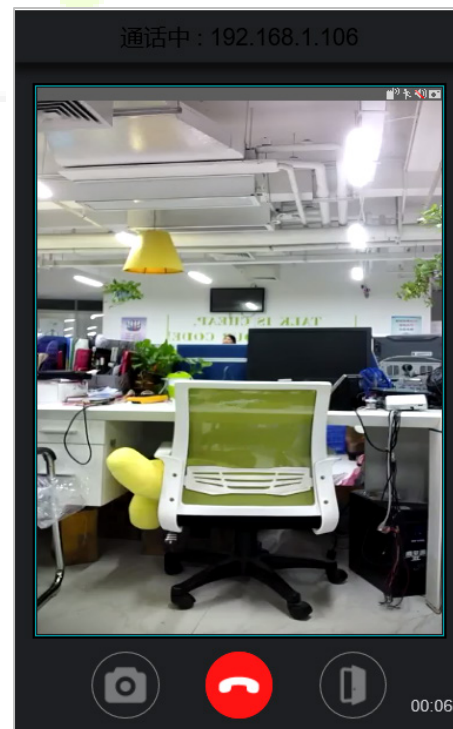







Call Interface

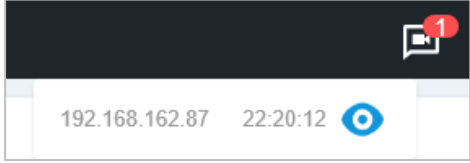

In-call Interface

Function Description

	It is the Answer key, the user can click to answer the current call. After answering, enter the window during the call, and turn on audio and video by default.
	It is the Hang up key. After hanging up, immediately end the current call.
	<p>It is the Ignore key, used to ignore the current call. Click it to close the call window, and the icon  in the upper right corner will display the number of pending calls, like this .</p> <p>The user can click the  icon in the drop-down menu to open the call window of the current device again and choose to answer, as shown following figure.</p> <div data-bbox="620 566 1091 728" style="text-align: center;">  </div>
	It is the Hang up key, used to hang up the current call.
	It is the Snapshot key, used to take a snapshot.
	It is the Remote Open key, used to open the door remotely. The default lock drive time is 5 seconds.

Note: If the device preview interface is opened on the ZKBioSecurity software, the call interface will no longer be displayed in this call window.

15 Connect to ZKBioAccess MTD Software★

15.1 Set the Communication Address

● Device Side

1. Tap **COMM.** > **Ethernet** in the main menu to set the IP address and gateway of the device.

(**Note:** The IP address should be able to communicate with the ZKBioAccess MTD server, preferably in the same network segment with the server address)

2. In the main menu, click **COMM.** > **Cloud Server Setting** to set the server address and server port.

Server address: Set the IP address as of ZKBioAccess MTD server.

Server port: Set the server port as of ZKBioAccess MTD (The default is 8088).

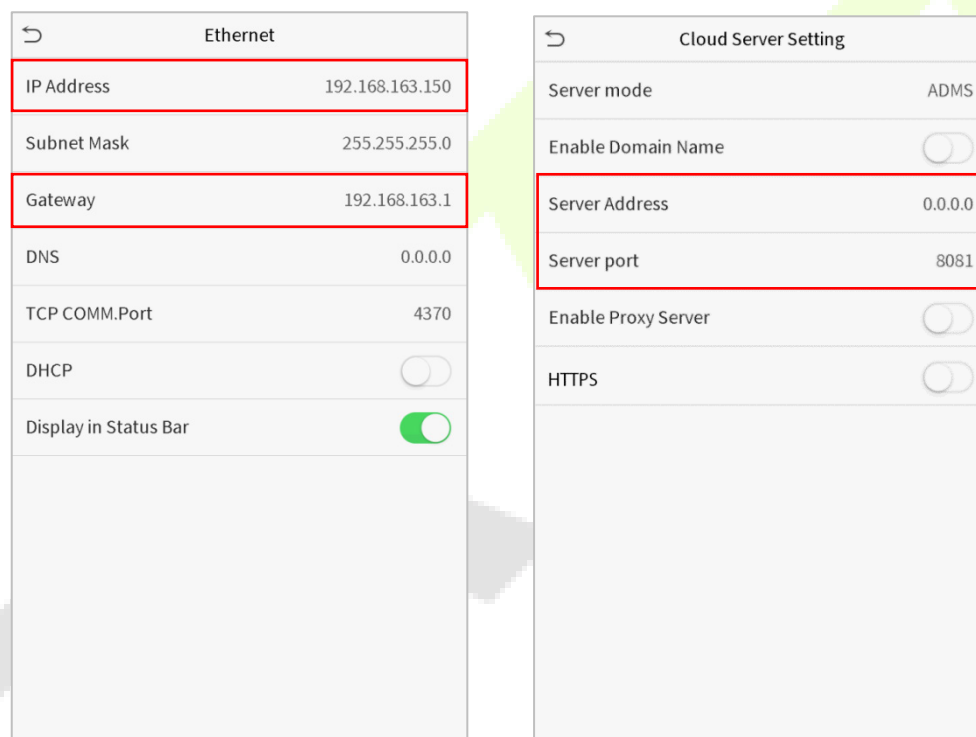

● Software Side

Login to ZKBioAccess MTD software, click **System** > **Communication** > **Communication Monitor** to set the ADMS service port, as shown in the figure below:

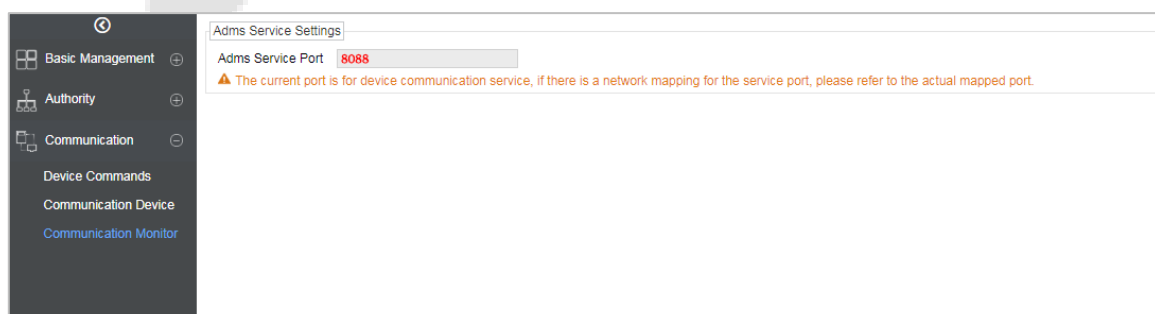

15.2 Add Device on the Software

Add the device by searching. The process is as follows:

1. Click **Access Control** > **Device** > **Search Device** to open the Search interface in the software.
2. Click **Search**, and it will prompt “**Searching.....**”.
3. After searching, the list and total number of access controllers will be displayed.

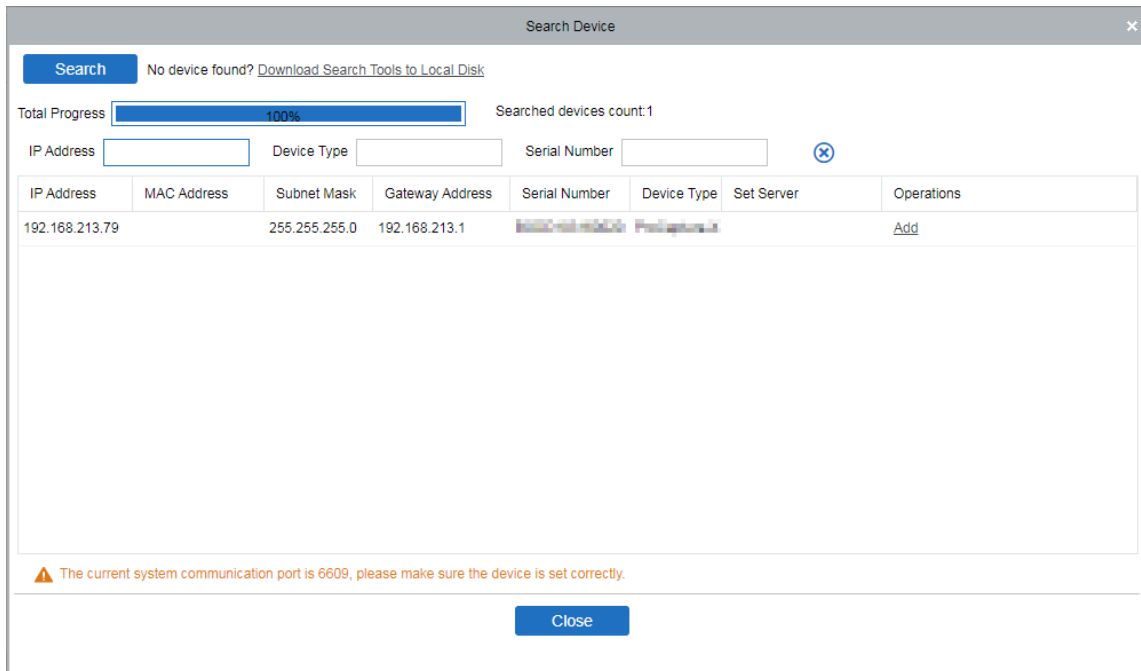

4. Click **Add** in operation column, a new window will pop-up. Select Icon type, Area, and Add to Level from each dropdown and click **OK** to add the device.

15.3 Add Personnel on the Software

1. Click **Personnel > Person > New**:

2. Fill in all the required fields and click **OK** to register a new user.
3. Click **Access > Device > Device Control > Synchronize All Data to Devices** to synchronize all the data to the device including the new users.

15.4 Real-time monitoring on the ZKBioAccess MTD Software

1. Click **Prevention > Epidemic > Temperature Detection > Real-time monitoring** to view all the personnel's events present under the Abnormal Temperature, No Masks, and Normal Records.

The user data of abnormal body temperature is displayed on the Abnormal Temperature information bar automatically according to the Temperature Threshold Setting is set.

- Click **Epidemic > Temperature Management > Statistics Panel** to view the analysis of statistical data in the form of a pie-chart and view the personnel with normal temperature, abnormal temperature, and unmeasured body temperature. Also, detailed information of the personnel can be seen on the right by clicking on the particular category on the pie-chart.

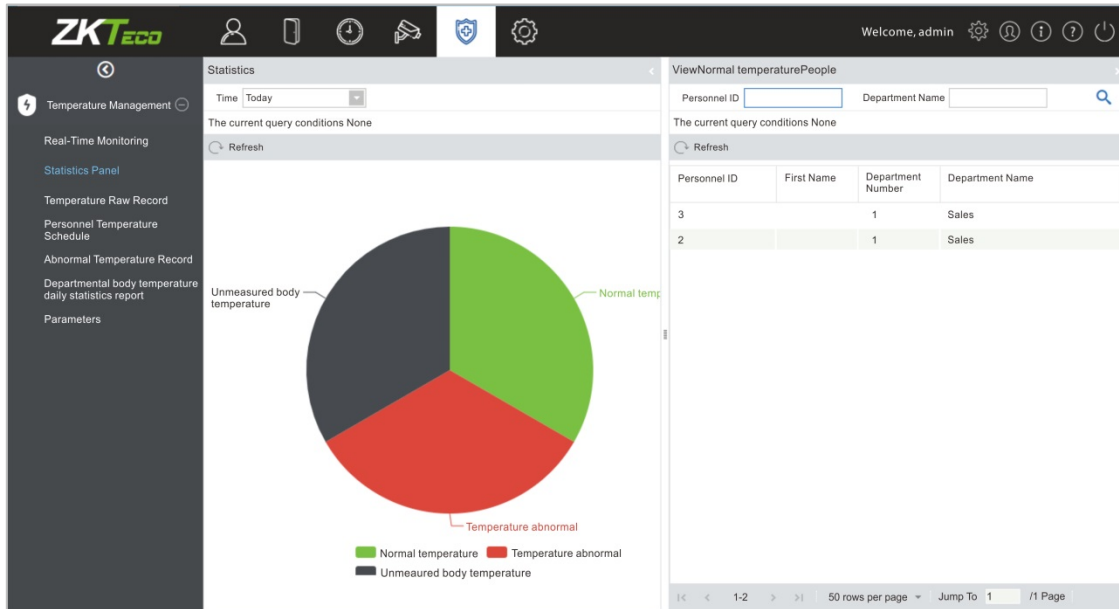

Note: For other specific operations, please refer to *ZKBioAccess MTD User Manual*.

16 Connecting to ZKBio Talk Software★

Download and install the ZKBio Talk software. Then, keep the parameter settings of ZKBioSecurity software unchanged for the relevant settings. (Please refer to [LAN Video Intercom Function Settings](#)).

Following are the steps to connect ZKBio Talk to the ZKBioSecurity software:

1. Firstly, change the parameter on the device.

Tap on  > **System** > **Video intercom parameters** > **Intercom Server Setting** on the device to change the server address and server port, as shown in the following figure.





Intercom Server Setting	
Server Address	192.168.163.61
Server port	25550

Server Address: Enter the current server installation IP address.

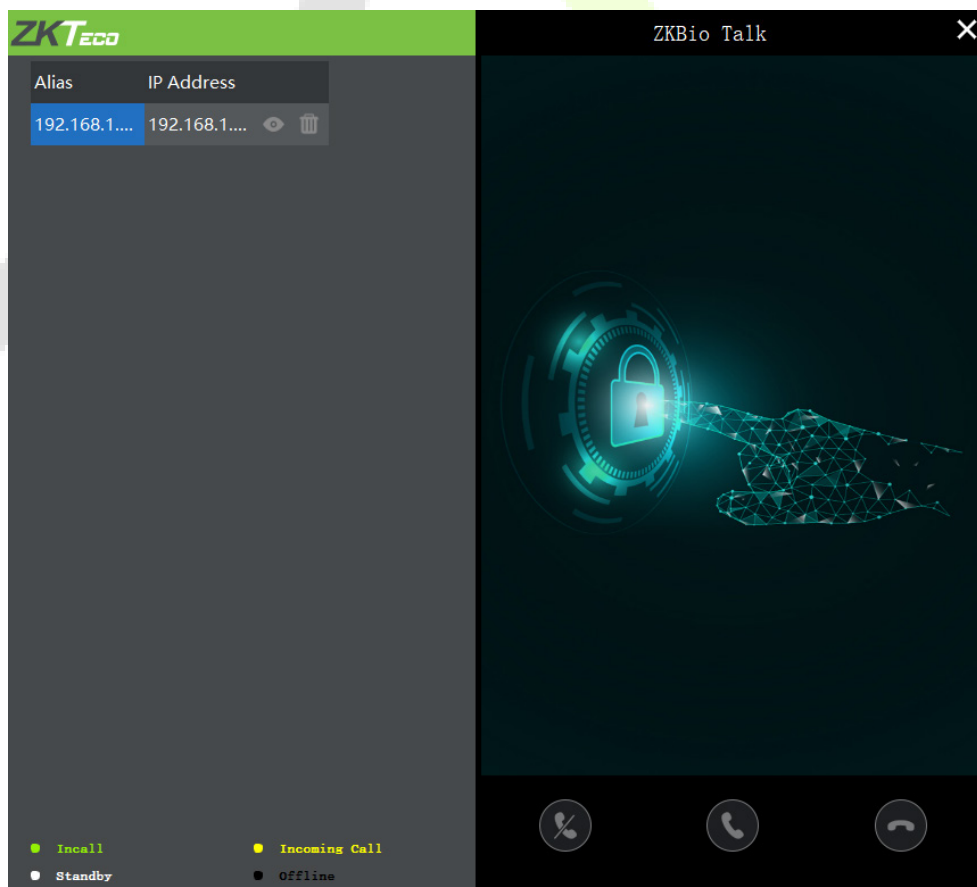
Server Port: The default server port is **25550**.

2. Double click the icon  to open the ZKBio Talk software. When the device-side video intercom parameters are set correctly, the device automatically pushes the device list on the left, as shown in following figure.



3. A user can click on  to preview the video on the right. On clicking  or  icon, a user can close the preview screen. No action is taken when  is clicked.

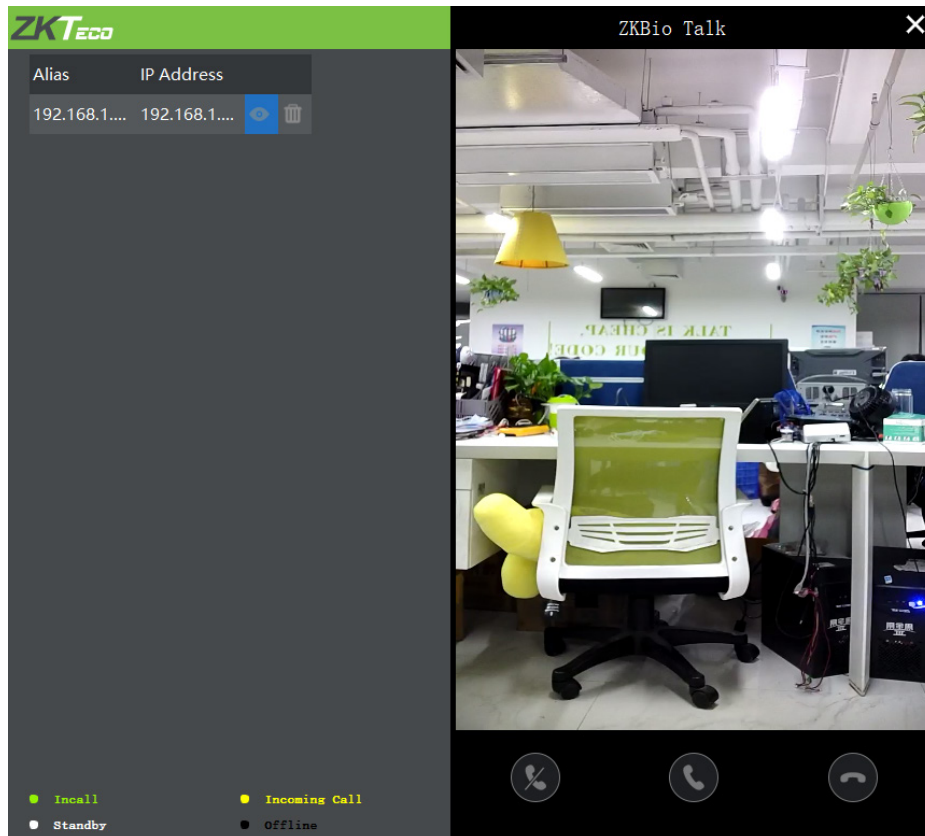

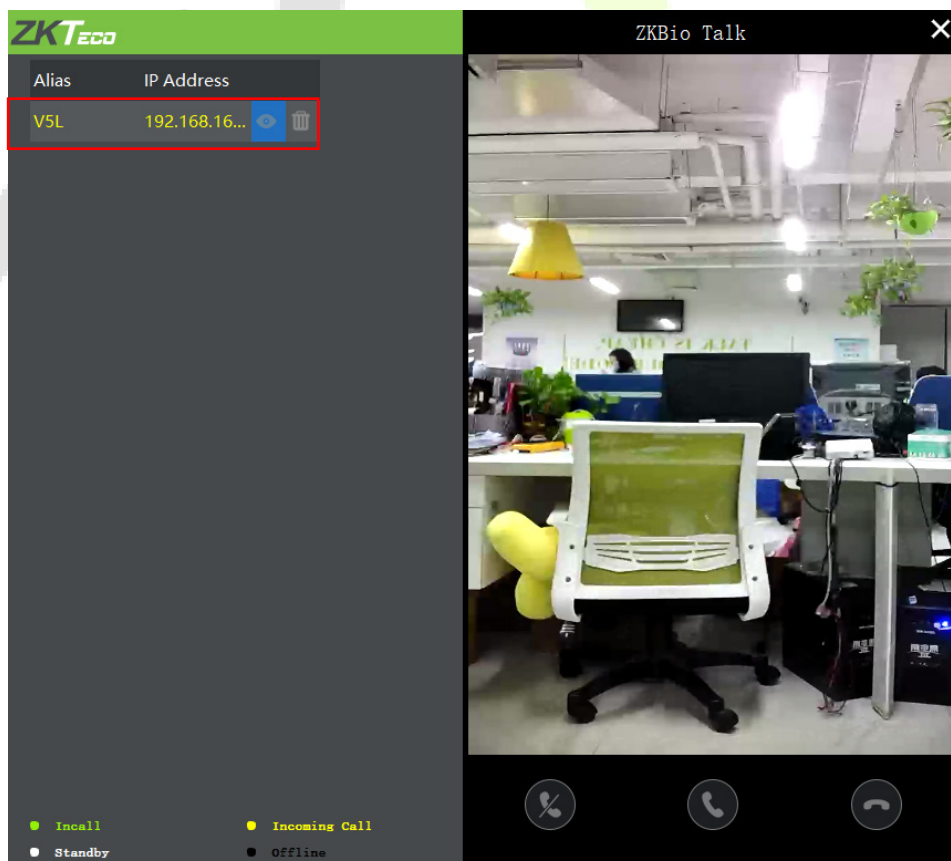

4. When a user clicks  icon on the main interface of the device to make a call, the software interface displays the IP address of the calling device in yellow.

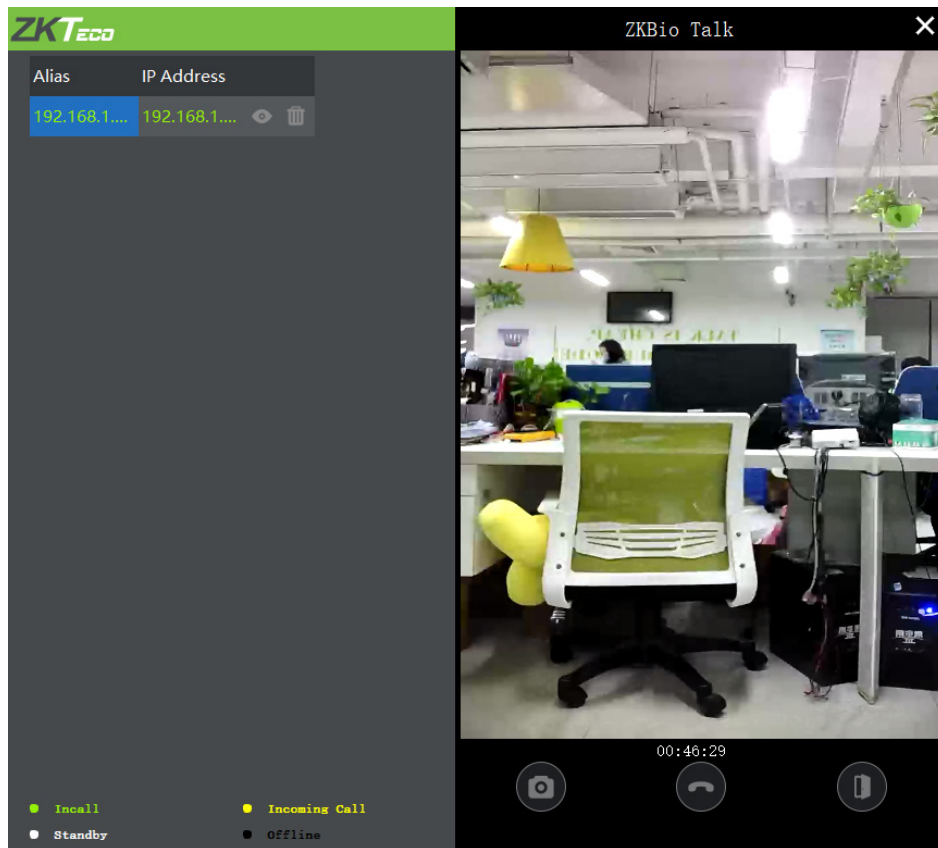

5. When the user clicks the  icon to answer the call, the IP address is displayed in green while on the call. The call duration is also displayed just above the icon.





Function Description:

	This is the Snapshot key, used to take a snapshot
	This is the Remote open key, used to open the door remotely. The default lock drive time is 5 seconds

Note: Only the offline devices can be removed.

17 Connecting to ZSmart APP★

17.1 Adding Device on the ZSmart APP

After downloading and installing the ZSmart APP on your phone, create a User account initially with your Email ID. After creating the User account, log in to the App, and click  or  icon on the top right corner of the screen to add a device. The process is as follows:

1. Click **Add Device** on the Home page.
2. Tap on **System > Video Intercom Parameters > QR Code Binding** to show the QR code of the device.
3. Click the  icon in the upper right corner.

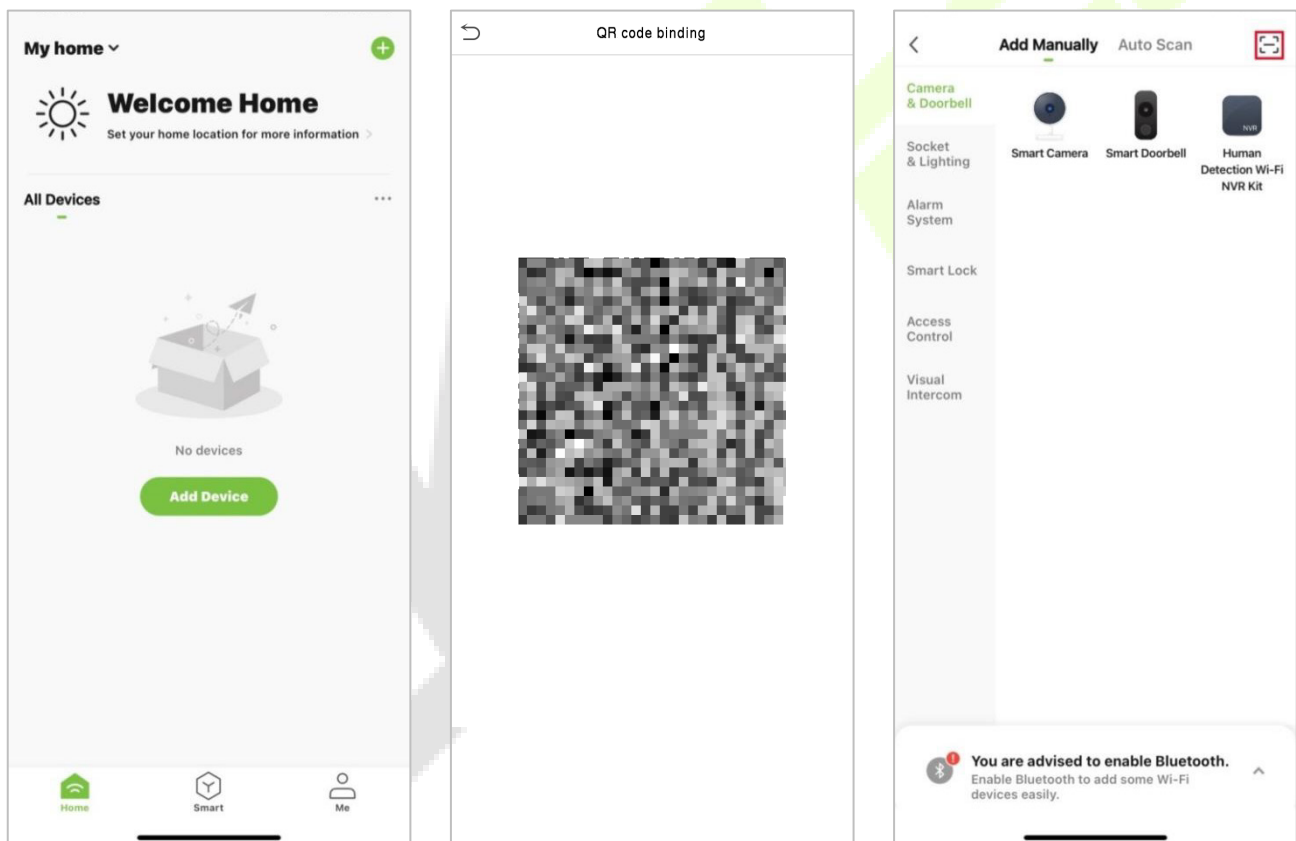

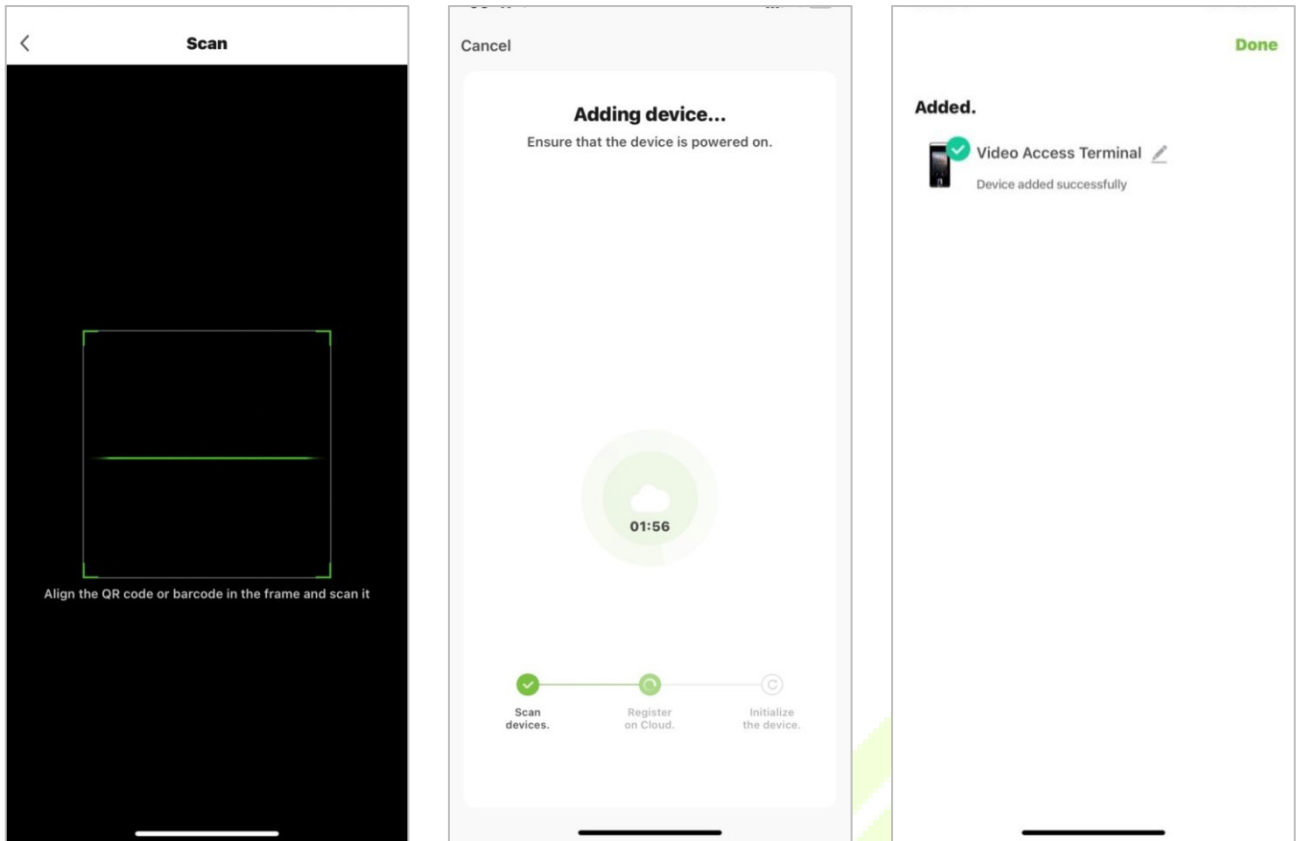

17.2 Video Phone Connection

Visitors press the  button on the device to make a call and the phone will ring. The user can accept or decline the call. After the user accepts the call, it will open the video door phone interface. Enter the password to unlock the door.

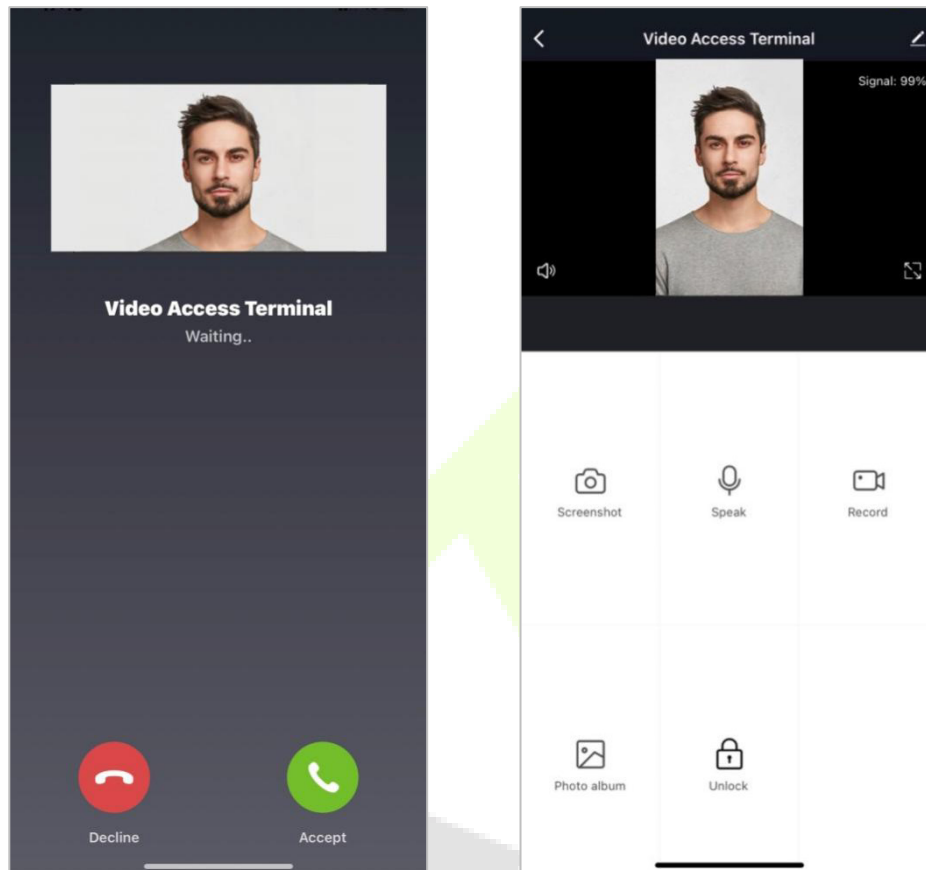

Parameter	Description
Screenshot	Click to take a screenshot.
Speak	The icon becomes blue when click it, and you can talk to the device at this time.
Record	Click to make a record video.
Photo album	View and delete screenshots and recorded videos.
Unlock	Click to open the door remotely. The unlocking record is saved in Me > Message Center .

Note: For other specific operations, please refer to the *ZSmartAPP User Manual*.

18 Connecting to SIP★

Tap **Video Intercom Parameters** on the **System** interface to go to the monitoring parameter settings.

Note: This function needs to be used with the indoor station Vpad A2.

SIP Settings	
Calling Delay(s)	30
Talking Delay(s)	60
Calling Shortcut Settings	
dtmf	1234
SIP Server	<input type="checkbox"/>
Server Address	192.168.1.203
Server Port	8080
User Name	106
Password	123456
realm	

Function Description

Function Name	Description
Calling Delay(s)	Set the time of call, valid value 30 to 60 seconds.
Talking Delay(s)	Set the time of intercom, valid value 60 to 120 seconds.
Calling Shortcut Settings	You can set a shortcut key to call the indoor station quickly without entering the IP address of the indoor unit each time.
dtmf	The value of WebServer is the same as the value of DMTF in the device in order to unlock it.
SIP Server	Select whether to enable the server address. Once you have connected to the server, you can call it by entering the username of the indoor station.
Server Address	Enter the server address.
Server Port	Enter the server port.
User Name	Enter the Username of server.
Password	Enter the password of server.
realm	Enter the realm of server.

The SpeedFace-V5L and the indoor station to achieve video intercom there are two modes, respectively, the LAN and SIP server.

18.1 Local Area Network Use

Set the IP address on the indoor station, Tap **Menu > Advanced > Network > 1. Network > 1. IPv4.**

Network		
Accounts	1. Connection Mode	Static IP
Network	2. IP Address	192.168.163.199
Security	3. Mask	255.255.255.0
Maintenance	4. Gateway	192.168.163.1
Device	5. Primary DNS	114.114.114.114
	6. Secondary DNS	8.8.8.8

Note: In LAN, the IP addresses of the indoor station and the SpeedFace-V5L must be in the same network segment.

- **Directly Enter the IP Address of the Indoor Station**

Once the indoor station is configured with the network, the video intercom function can be realized by tap the  icon on the SpeedFace-V5L screen and entering the IP address of the indoor station in the jumping interface.



- **Custom the Punch Status Options**

1. Use your browser to enter the address to log into WebSever, the address is the **Serial IP Address:1443**, for example: <https://192.168.163.99:1443>.

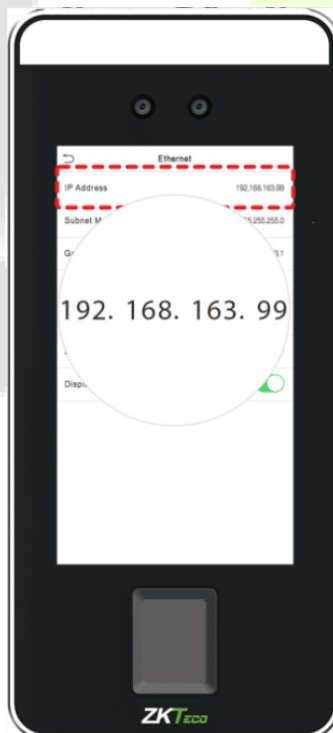

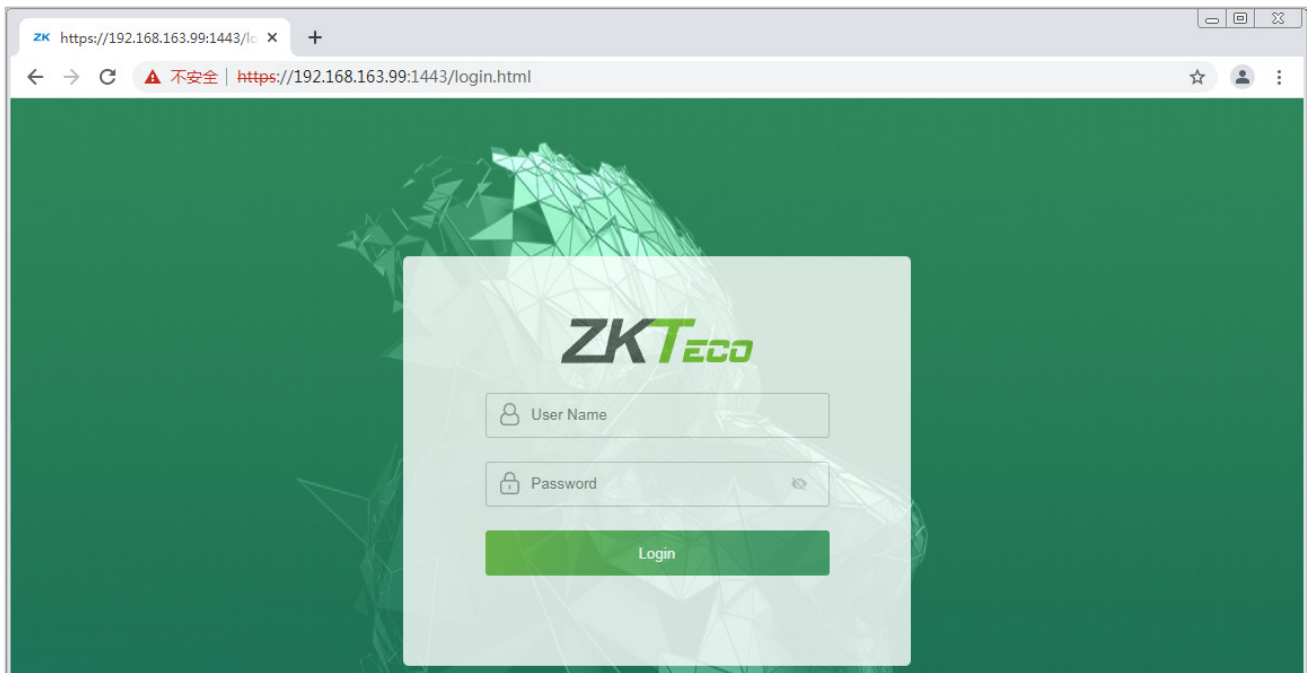
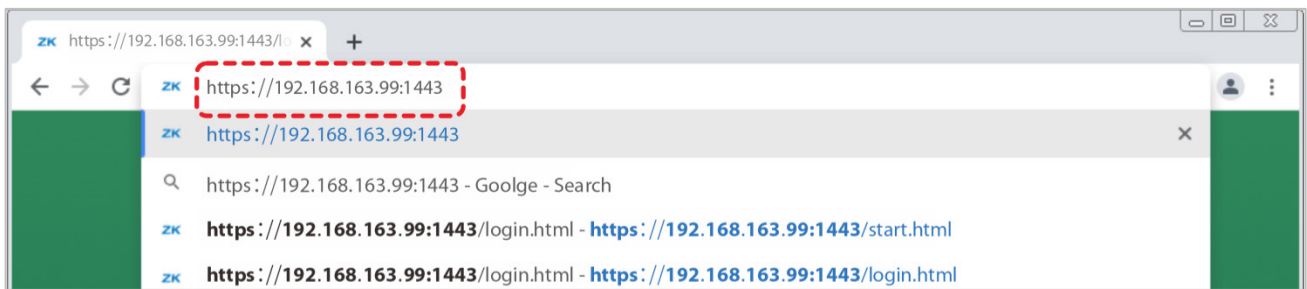

2. Enter the WebSever account and password, the initial account is: **admin**, password: **admin@123**.

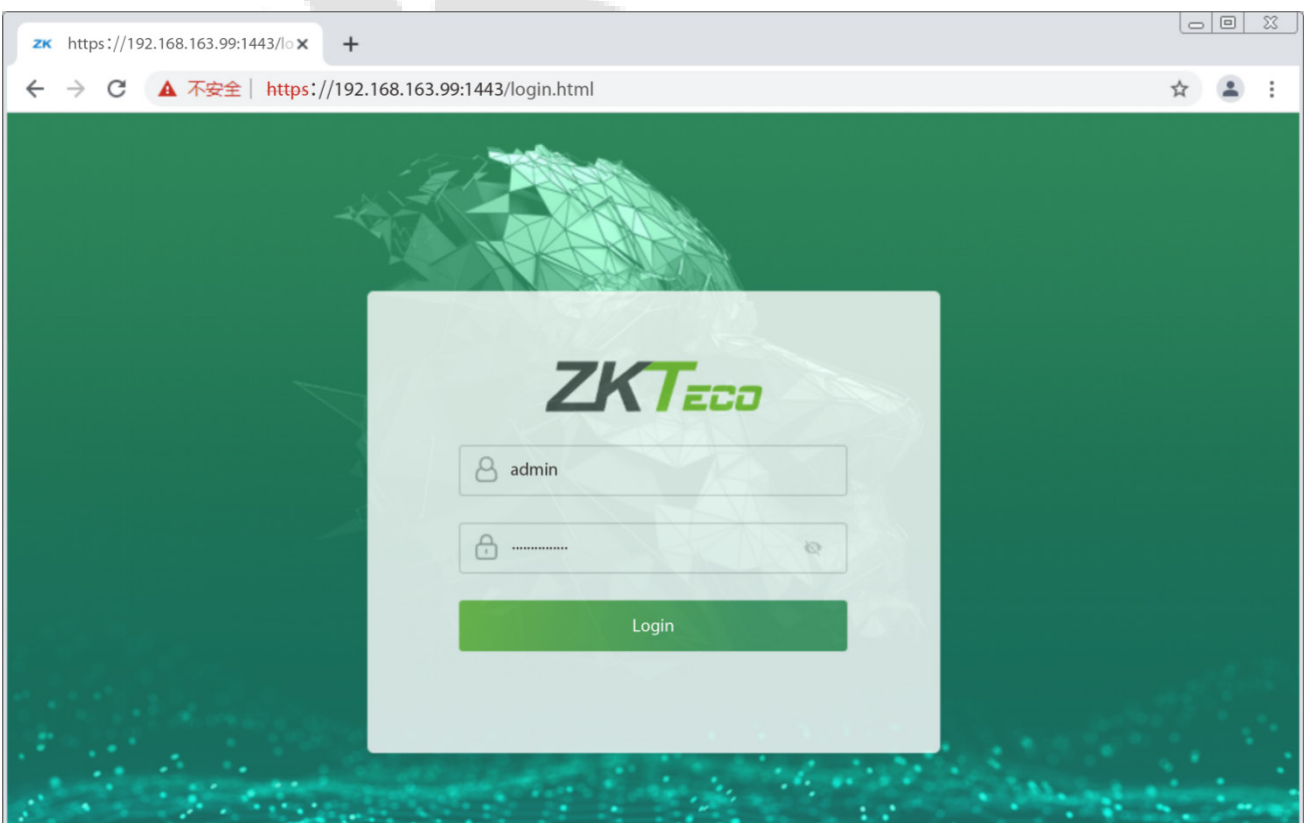

3. Download configuration data.

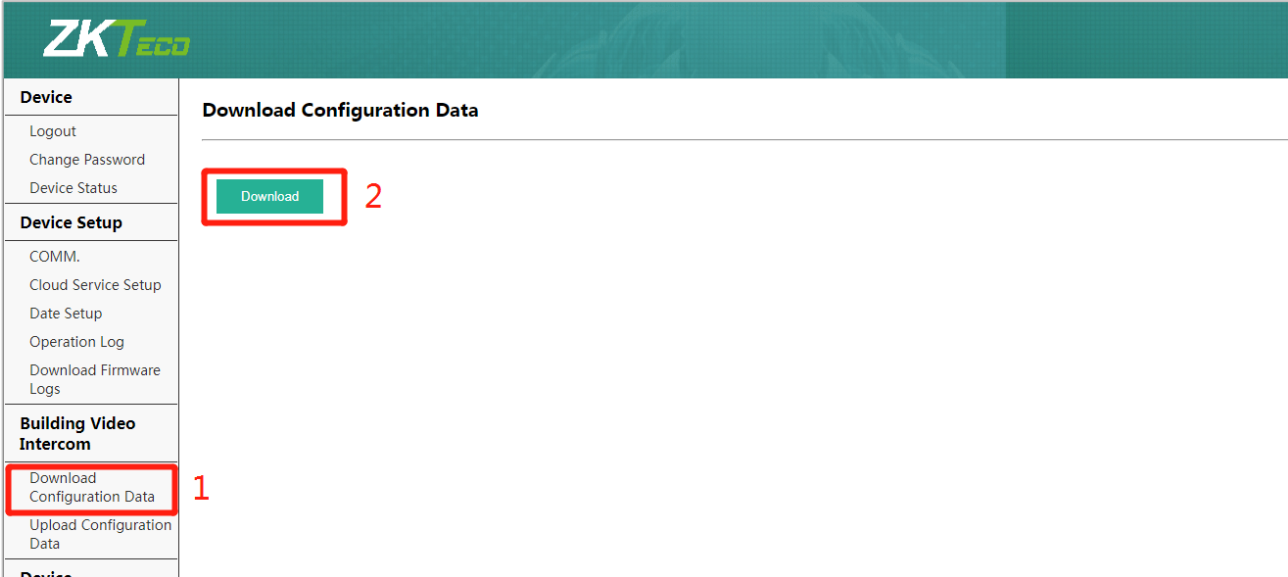

The screenshot shows the ZKTeco web interface. On the left sidebar, under the 'Building Video Intercom' section, the 'Download Configuration Data' option is highlighted with a red box and labeled '1'. The main content area is titled 'Download Configuration Data' and contains a 'Download' button, which is also highlighted with a red box and labeled '2'.

4. Enter the indoor station's communication address and device number in the downloadable form.

	A	B	C	D	E
1	IP Address	Subnet Mask	Gateway	Dialing Number	
2	192.168.163.199	255.255.255.0	192.168.163.1		9
3	192.168.163.205	255.255.255.0	192.168.163.1		3
4	192.168.163.103	255.255.255.0	192.168.163.1		4
5	192.168.163.104	255.255.255.0	192.168.163.1		5
6	192.168.163.105	255.255.255.0	192.168.163.1		6
7					

IP Address/Subnet Mask/Gateway: Must be the same as the indoor station to be connected.

Dialing Number: Customize the number of the indoor station, you can enter the value on SpeedFace-V5L to call the indoor station quickly for video intercom.

5. Once the form is set up and saved, upload the configuration form in WebSever.

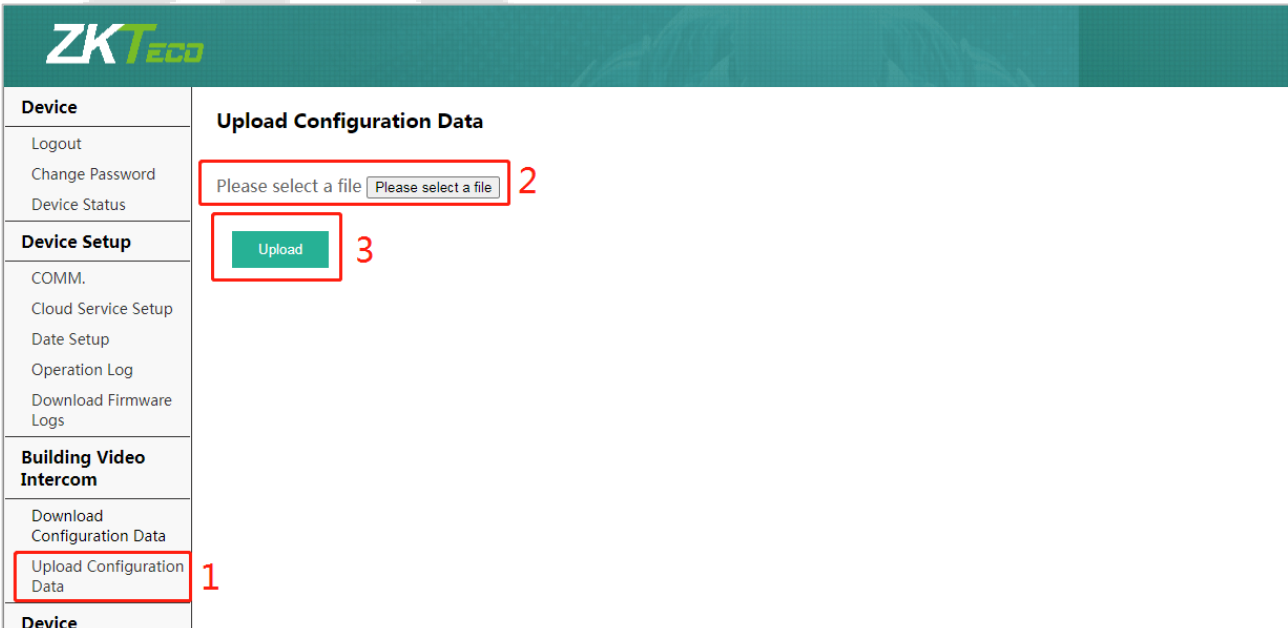

The screenshot shows the ZKTeco web interface. On the left sidebar, under the 'Building Video Intercom' section, the 'Upload Configuration Data' option is highlighted with a red box and labeled '1'. The main content area is titled 'Upload Configuration Data' and contains a file selection input field labeled 'Please select a file' (highlighted with a red box and labeled '2') and an 'Upload' button (highlighted with a red box and labeled '3').

6. On SpeedFace-V5L, tap **Calling Shortcut Settings**, select any item except admin, and enter the form information you just uploaded.

Function Description

Function Name	Description
Name	You can customize any character (support Chinese, English, numbers, symbols, etc.) that will be displayed on the call page.
Device Number	It is the dialing number in the configuration data, you can enter the value on SpeedFace-V5L to call the indoor station quickly for video intercom.
IP Address	After entering the dialing number, the corresponding IP address in the configuration data will be automatically paired.

- **Name**

You can then tap **199** on the punch status options to directly implement the video intercom.

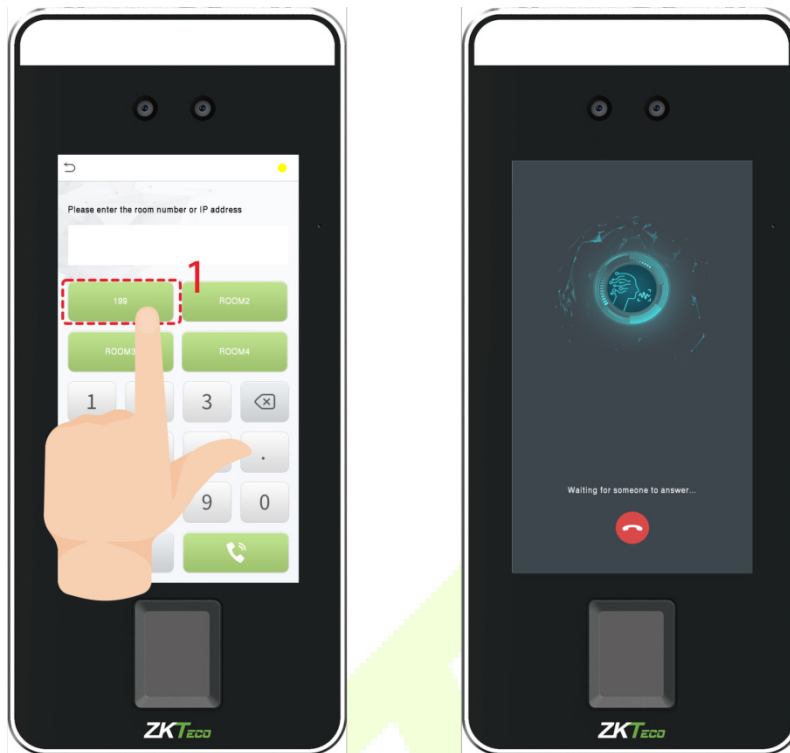

- **Device Number**

Enter the device number in the call screen.



18.2 SIP Server

On SpeedFace-V5L, tap **SIP Server**, after the device is rebooted, enter the server-related parameters, as shown below:

SIP Settings	
Calling Delay(s)	60
Talking Delay(s)	120
Calling Shortcut Settings	
dtmf	1234
SIP Server	<input checked="" type="checkbox"/>
Server Address	20.205.119.174
Server Port	5060
User Name	106
Password	123456
realm	3CXPhoneSystem

Once the SIP is set up correctly, a green dot will appear in the upper right corner of the call page to indicate that the SpeedFace-V5L is connected to the server. You can call the account name of the indoor station.

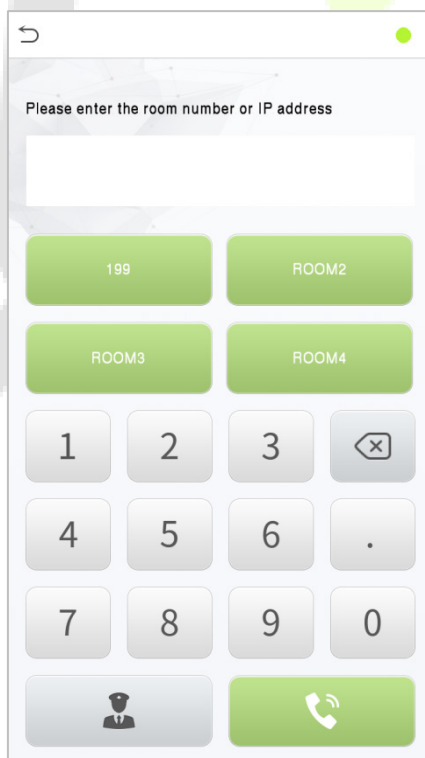

The screenshot shows the call interface with a green dot in the top right corner. The interface includes a text input field with the prompt "Please enter the room number or IP address". Below the input field is a keypad with buttons for "199", "ROOM2", "ROOM3", "ROOM4", and a standard numeric keypad (1-0, *, #). At the bottom, there are buttons for a user icon and a call button.

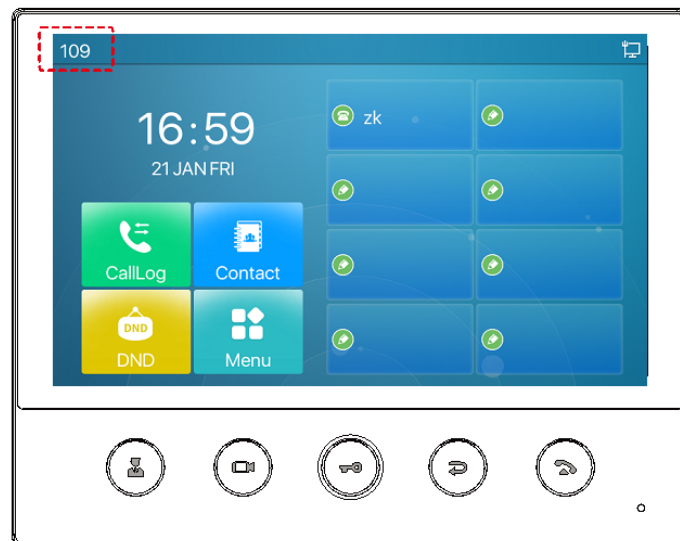

For details on the operation and use of the indoor station, please refer to the *indoor station user manual*.

19 Connecting to Bluetooth Lock★

Through this Bluetooth function, the Bluetooth lock can be bound to the device, and when the user passes the verification on the device or enters the correct Bluetooth lock code, the lock can be unlocked remotely.

Tap **Bluetooth Settings** on the **Comm. Settings** interface to set the Bluetooth.

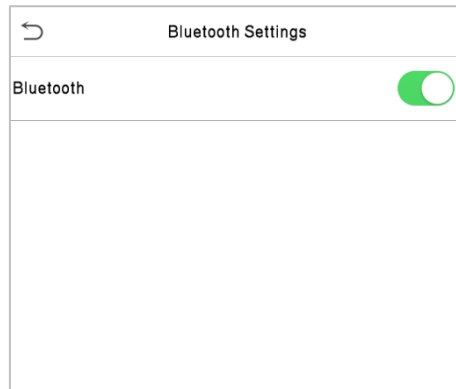

19.1 Bind Device

- Click **Bluetooth** to enable the Bluetooth function.
- You need to touch the Bluetooth lock keyboard to wake up the lock, the device will search through Bluetooth and display the Bluetooth lock to be bound on the **Bluetooth Settings** interface.

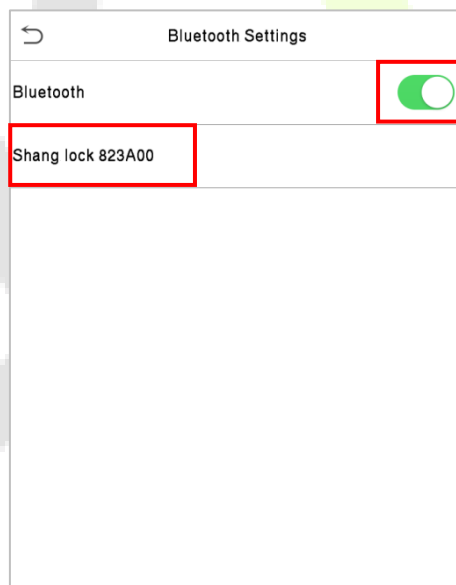

- Select the Bluetooth lock to be bound, enter the lock password setting interface.
- Please enter a 6 to 9 digit new password, click **Confirm** to save the password, then the interface will display "Unbound" after completion.

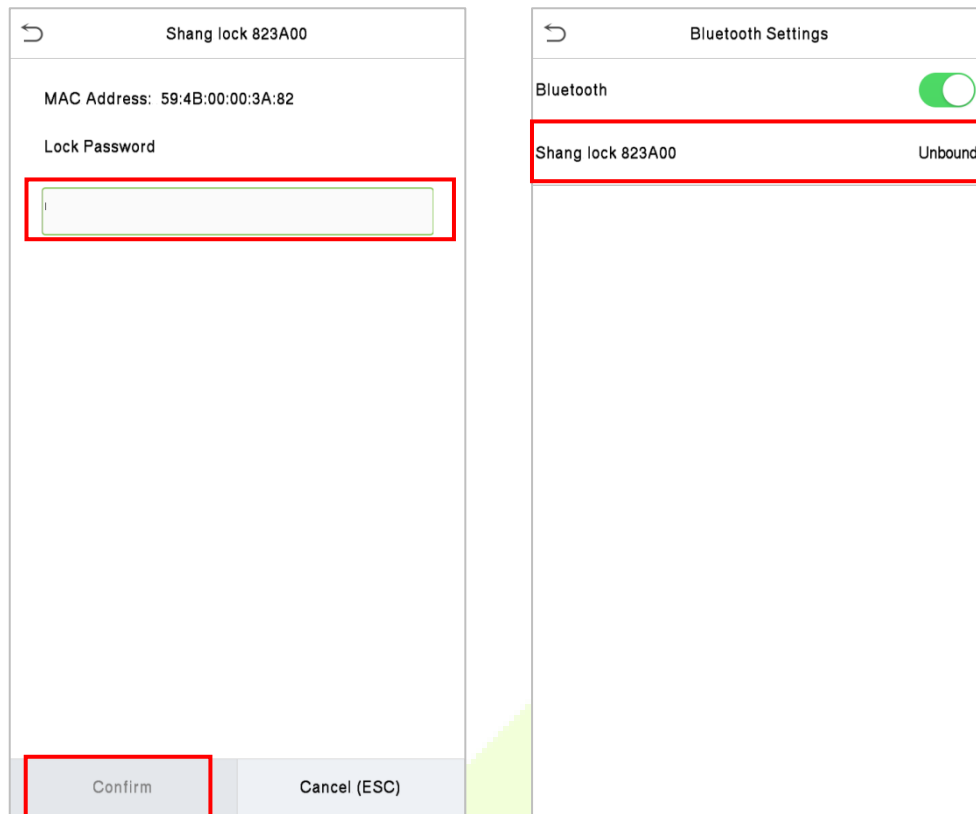

- Select the unbound Bluetooth lock again to enter the **Details** interface.
- Please touch the Bluetooth lock keyboard to wake up the device first, and then click **Linking Device**, the Bluetooth lock will emit a beep sound, and the interface will pop up a "Linked" prompt, indicating that the device is successfully bound.

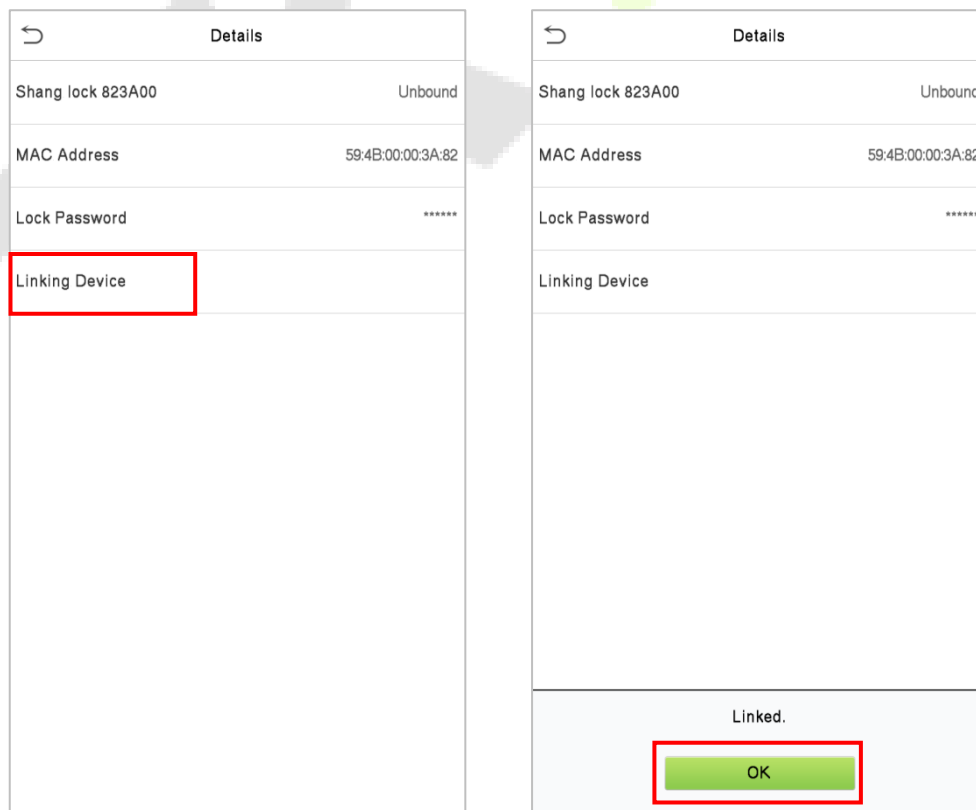

- After clicking **OK** on the successful binding interface, the device will automatically synchronize the setting lock password to the Bluetooth lock. The Bluetooth lock will emit a beep sound, and the device interface will pop up a "**Successfully set up.**" prompt, indicating that the device is successfully set.

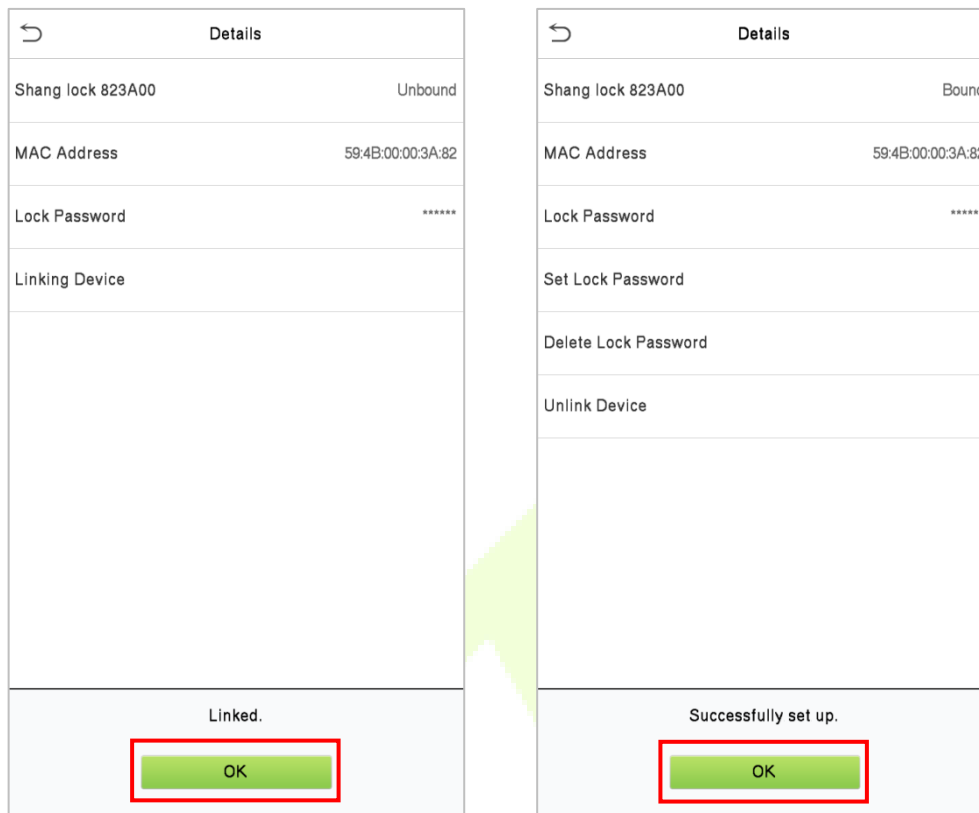

19.2 Change Password

- Tap on **Comm. > Bluetooth Settings**, select the bound Bluetooth lock, and enter the **Details** interface.
- Click **Lock Password** to open the password setting interface, enter the new password twice, and click **OK** to save.

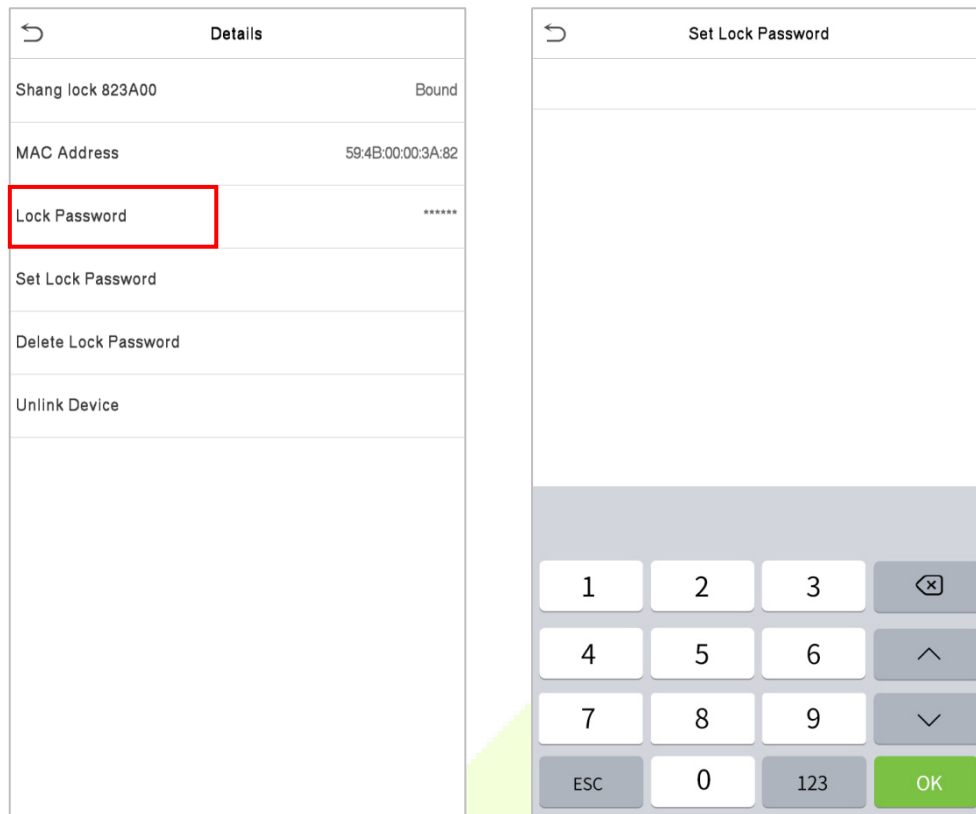

- Please touch the Bluetooth lock keyboard to wake up the device first, and then click **Set Lock Password** to synchronize the new password to the Bluetooth lock. The Bluetooth lock will emit a beep sound, and the device interface will pop up a **"Successfully set up."** prompt, indicating that the device is successfully set.

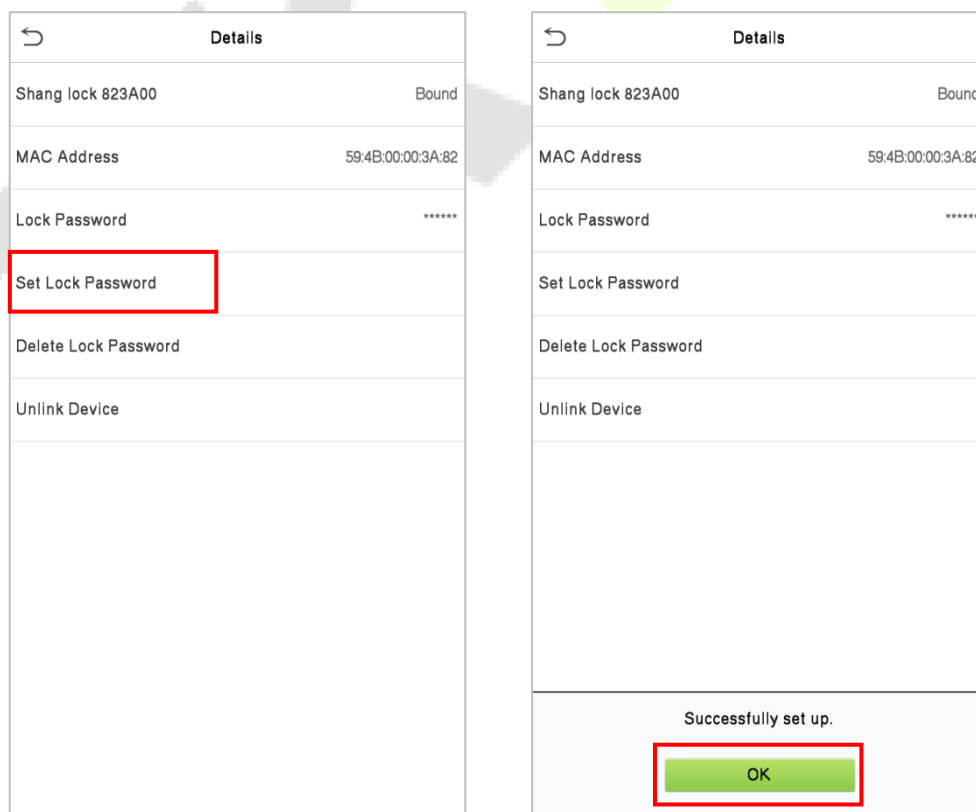

19.3 Delete Password

- Tap on **Comm.** > **Bluetooth Settings**, select the bound Bluetooth lock, and enter the **Details** interface.
- Please touch the Bluetooth lock keyboard to wake up the device first, and then click **Delete Lock Password**. The Bluetooth lock will emit a beep sound, and the interface will pop up a "**Removed.**" prompt, indicating that the password has been deleted successfully.

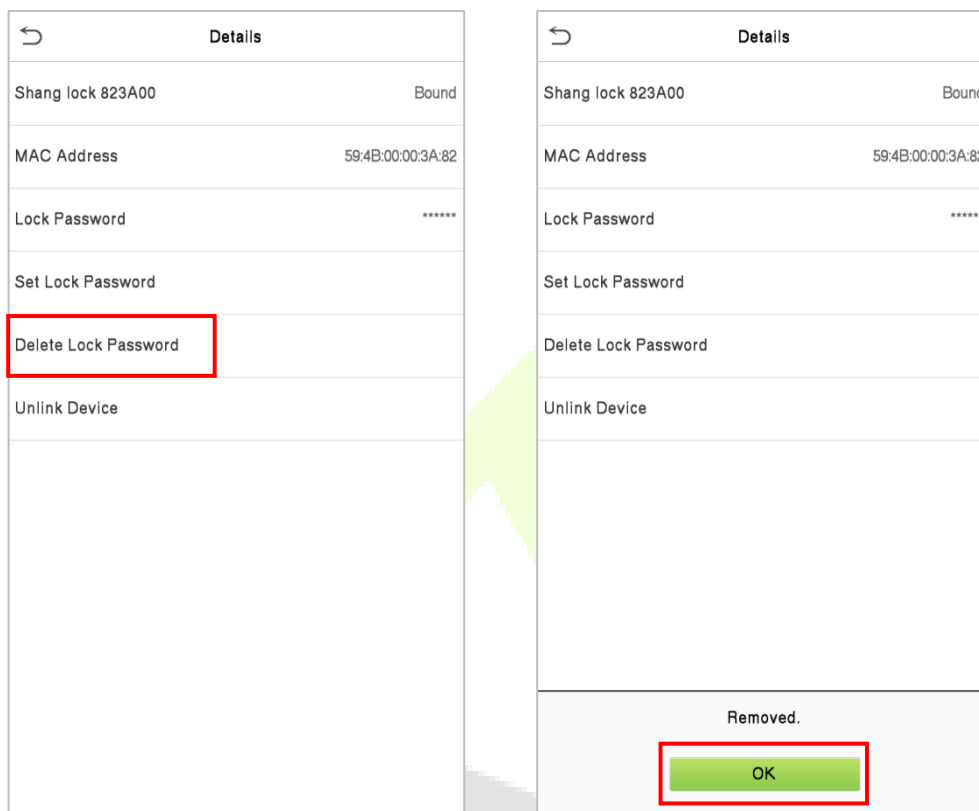

Note: After deleting the password, the Bluetooth lock will be restored to the original password: 123456.

19.4 Unbind Device

- Tap on **Comm.** > **Bluetooth Settings**, select the bound Bluetooth lock, and enter the **Details** interface.
- Please touch the Bluetooth lock keyboard to wake up the device first, and then click **Unlink Device** on the **Details** interface. The interface will pop up a "**Are you sure to unlink the device?**" prompt, then click **OK**.

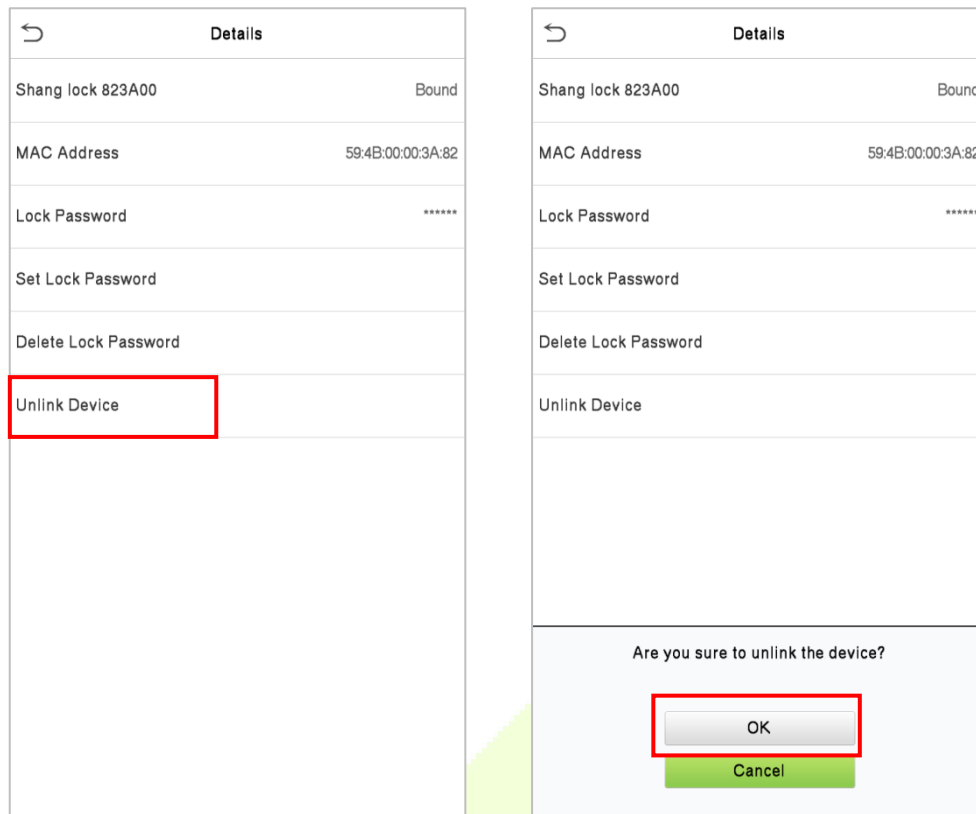

- After the Bluetooth lock emits a beep sound, the interface will pop up a "**Successfully unlinked.**" prompt, indicating that the unbinding of the device is complete.

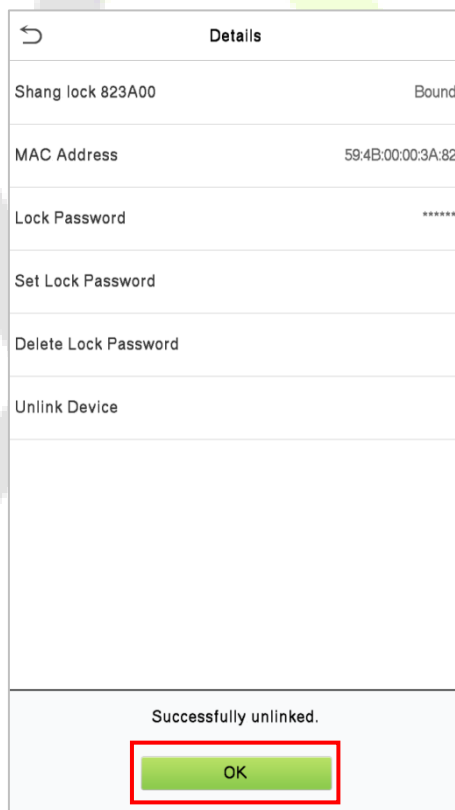

Note: After the device is unbound, the Bluetooth lock will be restored to the original password: 123456.

19.5 Unlock

After the user binds the Bluetooth lock to the device, the lock can be unlocked through a password or remotely through the device.

- **Unlock via Password**

After changing the password on the device, you can enter this password on the Bluetooth lock keyboard to unlock it.

- **Unlock via SpeedFace-V5L**

After binding the Bluetooth lock to the device, the Bluetooth lock can be opened remotely when the user verifies that the face, card, fingerprint or password on the device.

After verification, the interface pops up an "**Unlocking via Bluetooth**" prompt, and the lock is opened after 5 seconds.

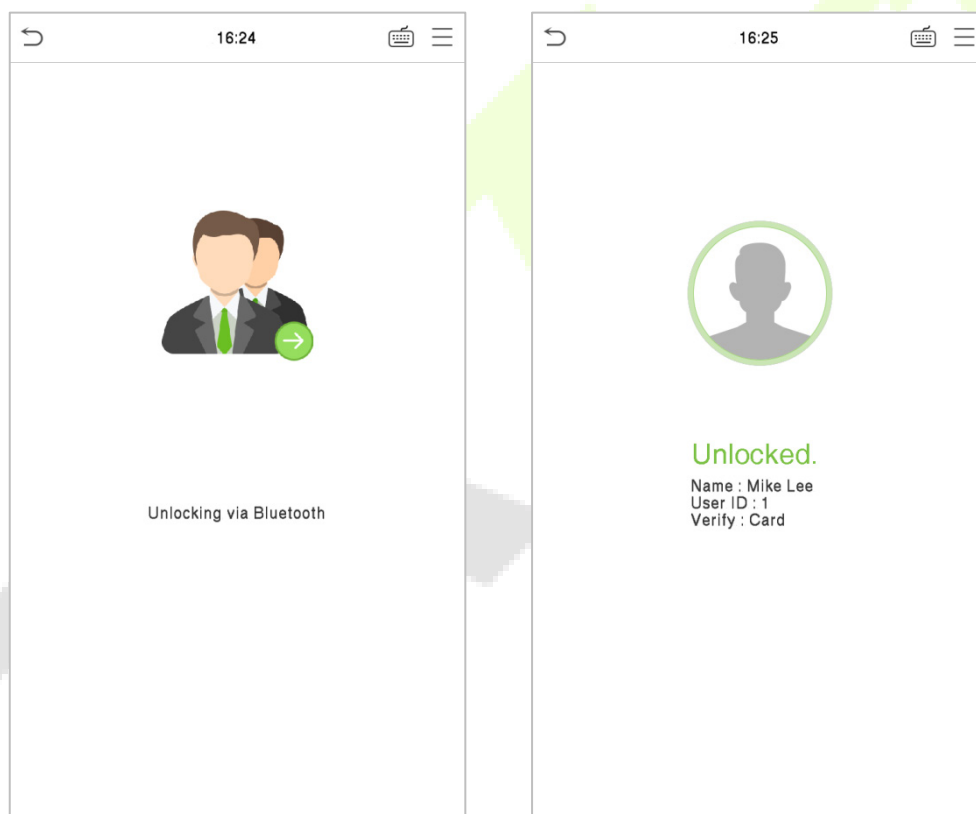

Appendix 1

Requirements of Live Collection and Registration of Visible Light Face Images

- 1) It is recommended to perform registration in an indoor environment with an appropriate light source without underexposure or overexposure on the face.
- 2) Do not place the device towards outdoor light sources like door or window or other harsh light sources.
- 3) Dark-color apparels other than the background color are recommended for registration.
- 4) Expose your face and forehead properly and do not cover your face and eyebrows with your hair.
- 5) It is recommended to show a normal facial expression. (A smile is acceptable, but do not close your eyes, or incline your head to any orientation).
- 6) Two images are required for persons with eyeglasses, one image with eyeglasses and one other without them.
- 7) Do not wear accessories like scarf or mask that may cover your mouth or chin.
- 8) Please face right towards the capturing device and locate your face in the image capturing area as shown in the image below.
- 9) Do not include more than one face in the capturing area.
- 10) A distance of 50cm to 80cm is recommended for capturing the image. (the distance is adjustable, subject to body height).

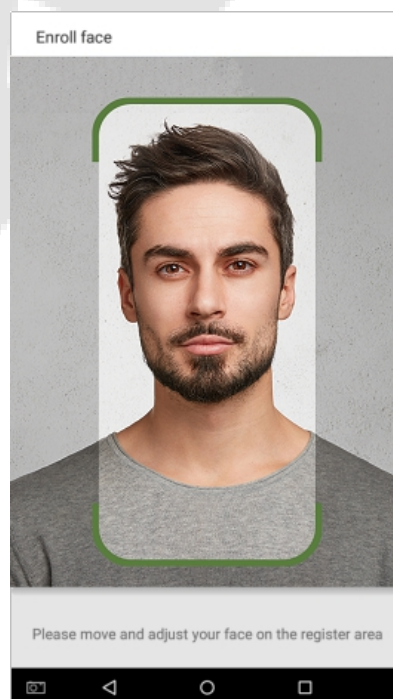

Requirements for Visible Light Digital Face Image Data

The digital photo should be straight-edged, coloured, half-portrayed with only one person, and the person should be uncharted and in casuals. Persons who wear eyeglasses should remain to put on eyeglasses for getting photos captured.

- **Eye Distance**

200 pixels or above are recommended with no less than 115 pixels of distance.

- **Facial Expression**

A neutral face or smile with eyes naturally open are recommended.

- **Gesture and Angel**

The horizontal rotating angle should not exceed $\pm 10^\circ$, elevation should not exceed $\pm 10^\circ$, and depression angle should not exceed $\pm 10^\circ$.

- **Accessories**

Masks or coloured eyeglasses are not allowed. The frame of the eyeglasses should not cover the eyes and should not reflect light. For persons with thick eyeglasses frames, it is recommended to capture two images, one with eyeglasses and the other one without them.

- **Face**

Complete face with clear contour, real scale, evenly distributed light, and no shadow.

- **Image Format**

Should be in BMP, JPG or JPEG.

- **Data Requirement**

Should comply with the following requirements:

- 1) White background with dark-coloured apparel.
- 2) 24bit true color mode.
- 3) JPG format compressed image with not more than 20kb size.
- 4) Resolution should be between 358 x 441 to 1080 x 1920.
- 5) The vertical scale of head and body should be in a ratio of 2:1.
- 6) The photo should include the captured person's shoulders at the same horizontal level.
- 7) The captured person's eyes should be open and with clearly seen iris.
- 8) A neutral face or smile is preferred, showing teeth is not preferred.
- 9) The captured person should be easily visible, natural in color, no harsh shadow or light spot or reflection in the face or background. The contrast and lightness level should be appropriate.

Appendix 2

Privacy Policy

Notice:

To help you better use the products and services of ZKTeco and its affiliates, hereinafter referred as "we", "our", or "us", the smart service provider, we consistently collect your personal information. Since we understand the importance of your personal information, we took your privacy sincerely and we have formulated this privacy policy to protect your personal information. We have listed the privacy policies below to precisely understand the data and privacy protection measures related to our smart products and services.

Before using our products and services, please read carefully and understand all the rules and provisions of this Privacy Policy. If you do not agree to the relevant agreement or any of its terms, you must stop using our products and services.

I. Collected Information

To ensure the normal product operation and help the service improvement, we will collect the information voluntarily provided by you or provided as authorized by you during registration and use or generated as a result of your use of services.

1. **User Registration Information:** At your first registration, the feature template (**Fingerprint template/Face template/Palm template**) will be saved on the device according to the device type you have selected to verify the unique similarity between you and the User ID you have registered. You can optionally enter your Name and Code. The above information is necessary for you to use our products. If you do not provide such information, you cannot use some features of the product regularly.
2. **Product information:** According to the product model and your granted permission when you install and use our services, the related information of the product on which our services are used will be collected when the product is connected to the software, including the Product Model, Firmware Version Number, Product Serial Number, and Product Capacity Information. **When you connect your product to the software, please carefully read the privacy policy for the specific software.**

II. Product Security and Management

1. When you use our products for the first time, you shall set the Administrator privilege before performing specific operations. Otherwise, you will be frequently reminded to set the Administrator privilege when you enter the main menu interface. **If you still do not set the Administrator privilege after receiving the system prompt, you should be aware of the possible security risk (for example, the data may be manually modified).**

2. All the functions of displaying the biometric information are disabled in our products by default. You can choose Menu > System Settings to set whether to display the biometric information. If you enable these functions, we assume that you are aware of the personal privacy security risks specified in the privacy policy.
3. Only your user ID is displayed by default. You can set whether to display other user verification information (such as Name, Department, Photo, etc.) under the Administrator privilege. **If you choose to display such information, we assume that you are aware of the potential security risks (for example, your photo will be displayed on the device interface).**
4. The camera function is disabled in our products by default. If you want to enable this function to take pictures of yourself for attendance recording or take pictures of strangers for access control, the product will enable the prompt tone of the camera. **Once you enable this function, we assume that you are aware of the potential security risks.**
5. All the data collected by our products is encrypted using the AES 256 algorithm. All the data uploaded by the Administrator to our products are automatically encrypted using the AES 256 algorithm and stored securely. If the Administrator downloads data from our products, we assume that you need to process the data and you have known the potential security risk. In such a case, you shall take the responsibility for storing the data. You shall know that some data cannot be downloaded for sake of data security.
6. All the personal information in our products can be queried, modified, or deleted. If you no longer use our products, please clear your personal data.

III. How we handle personal information of minors

Our products, website and services are mainly designed for adults. Without consent of parents or guardians, minors shall not create their own account. If you are a minor, it is recommended that you ask your parents or guardian to read this Policy carefully, and only use our services or information provided by us with consent of your parents or guardian.

We will only use or disclose personal information of minors collected with their parents' or guardians' consent if and to the extent that such use or disclosure is permitted by law or we have obtained their parents' or guardians' explicit consent, and such use or disclosure is for the purpose of protecting minors.

Upon noticing that we have collected personal information of minors without the prior consent from verifiable parents, we will delete such information as soon as possible.

IV. Others

You can visit https://www.zkteco.com/cn/index/Index/privacy_protection.html to learn more about how we collect, use, and securely store your personal information. To keep pace with the rapid development of technology, adjustment of business operations, and to cope with customer needs, we will constantly deliberate and optimize our privacy protection measures and policies. Welcome to visit our official website at any time to learn our latest privacy policy.



Eco-friendly Operation



The product's "eco-friendly operational period" refers to the time during which this product will not discharge any toxic or hazardous substances when used in accordance with the prerequisites in this manual.

The eco-friendly operational period specified for this product does not include batteries or other components that are easily worn down and must be periodically replaced. The battery's eco-friendly operational period is 5 years.

Hazardous or Toxic substances and their quantities

Component Name	Hazardous/Toxic Substance/Element					
	Lead (Pb)	Mercury (Hg)	Cadmium (Cd)	Hexavalent Chromium (Cr6+)	Polybrominated Biphenyls (PBB)	Polybrominated Diphenyl Ethers (PBDE)
Chip Resistor	×	○	○	○	○	○
Chip Capacitor	×	○	○	○	○	○
Chip Inductor	×	○	○	○	○	○
Diode	×	○	○	○	○	○
ESD component	×	○	○	○	○	○
Buzzer	×	○	○	○	○	○
Adapter	×	○	○	○	○	○
Screws	○	○	○	×	○	○

○ indicates that the total amount of toxic content in all the homogeneous materials is below the limit as specified in SJ/T 11363—2006.

×

× indicates that the total amount of toxic content in all the homogeneous materials exceeds the limit as specified in SJ/T 11363—2006.

Note: 80% of this product's components are manufactured using non-toxic and eco-friendly materials. The components which contain toxins or harmful elements are included due to the current economic or technical limitations which prevent their replacement with non-toxic materials or elements.

ZKTeco Industrial Park, No. 32, Industrial Road,
Tangxia Town, Dongguan, China.
Phone : +86 769 - 82109991
Fax : +86 755 - 89602394
www.zkteco.com

